

4-2-4  
CATALOGUED

H. C. BARNETT

**THE**

---

**MOSQUITOES**

---

**OF**

---

**ALASKA**

Agriculture Handbook No. 182

Agricultural Research Service  
UNITED STATES DEPARTMENT OF AGRICULTURE

The purpose of this handbook is to present information on the biology, distribution, identification, and control of the species of mosquitoes known to occur in Alaska. Much of this information has been published in short papers in various journals and is not readily available to those who need a comprehensive treatise on this subject; some of the material has not been published before. The information brought together here will serve as a guide for individuals and communities that have an interest and responsibility in mosquito problems in Alaska. In addition, the military services will have considerable use for this publication at their various installations in Alaska.

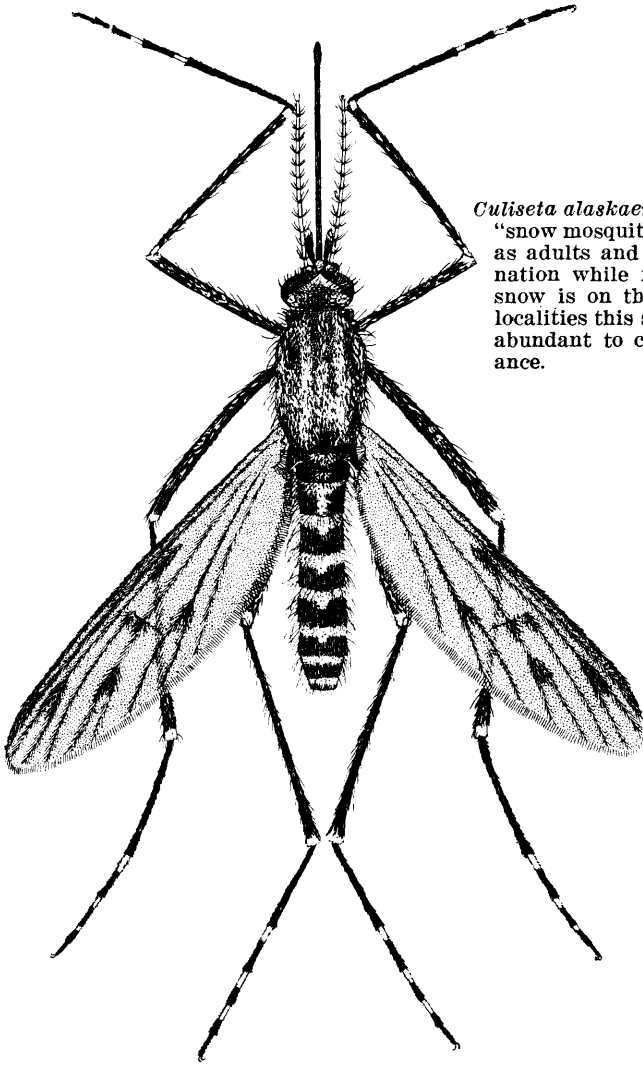

PN-807

*Culiseta alaskaensis*, one of the large "snow mosquitoes" that overwinter as adults and emerge from hibernation while much of the winter snow is on the ground. In some localities this species is sufficiently abundant to cause serious annoyance.

# **THE**

---

# **MOSQUITOES**

---

# **OF ALASKA**

By C. M. GJULLIN, R. I. SAILER, ALAN STONE, and B. V. TRAVIS

Agriculture Handbook No. 182

Agricultural Research Service

UNITED STATES DEPARTMENT OF AGRICULTURE

Washington, D.C.

Issued January 1961

---

For sale by the Superintendent of Documents, U.S. Government Printing Office  
Washington 25, D.C. - Price 45 cents

## Contents

	Page		Page
History of mosquito abundance and control.....	1	Biology—Continued	
Mosquito literature.....	3	Oviposition.....	25
Economic losses.....	4	Hibernation.....	25
Mosquito-control organizations.....	5	Surveys of the mosquito problem.....	25
Life history.....	5	Mosquito surveys.....	25
Eggs.....	6	Engineering surveys.....	29
Larvae.....	6	Methods of mosquito control.....	29
Pupae.....	6	Control of larvae.....	30
Adults.....	6	Environmental control.....	30
Distribution.....	7	Control with insecticides.....	31
Abundance.....	11	Protection against adults.....	32
Predicting abundance.....	12	Personal protection.....	33
Effects of weather on mosquito activity.....	14	Insecticides.....	34
Biology.....	16	Control of resistant mosquitoes.....	39
Larval habitats.....	16	Technique for mosquito collection and survey.....	39
Habitat preferences and relative economic importance of species.....	21	Identification of species.....	42
Water temperature of larval habitats.....	22	Keys and notes for identification.....	42
Adult food habits.....	23	Genus <i>Aedes</i> Meigen.....	45
Longevity.....	23	Genus <i>Culiseta</i> Felt.....	71
Flight range.....	23	Genus <i>Anopheles</i> Meigen.....	77
Mating.....	24	Genus <i>Culex</i> Linnaeus.....	79
		Literature cited.....	81
		Appendix.....	87



# THE MOSQUITOES OF ALASKA

By C. M. GJULLIN, R. I. SAILER, ALAN STONE, and B. V. TRAVIS,<sup>1</sup> entomologists,  
Entomology Research Division, Agricultural Research Service

## History of Mosquito Abundance and Control

The mosquito problem in Alaska seems to have changed very little since it was first recorded by early travelers and explorers. The first reconnaissance of Alaska after its purchase from Russia in 1867 was made by Raymond (94)<sup>2</sup> of the U.S. Army Engineer Corps in 1869. During his voyage up the Yukon River by steamboat, mosquitoes were present in large numbers. He wrote:

The swarms of mosquitoes and gnats which abound on the river during the months of June and July proved a very serious annoyance. When the boat was not in motion, we were obliged to wear face nets and gloves; and on one occasion an attempt to make sextant observations failed completely from this cause. The mosquitoes are much larger than those met with in lower latitudes.

Petrof (89), while investigating the population and resources of Alaska in 1880, found mosquitoes to be a severe annoyance in the lower Kuskokwim Valley. He wrote:

There is another feature in this country which, though insignificant on paper, is to the traveler the most terrible and poignant infliction he can be called upon to bear in a new land. I refer to the clouds of bloodthirsty mosquitoes, accompanied by a vindictive ally in the shape of a small poisonous black fly, under the stress of whose persecution the strongest man with the firmest will must either feel depressed or succumb to low

fever. . . . The traveler who exposes his bare eyes or face here loses his natural appearance; his eyelids swell up and close, and his face becomes one mass of lumps and fiery pimples. Mosquitoes torture the Indian dogs to death, especially if one of these animals, by mange or otherwise, loses an inconsiderable portion of its thick hairy covering, and even drive the bear and the deer into the water.

During a military reconnaissance of the Copper River Valley in 1898 under the direction of Abercrombie (1), captain of the Second U.S. Infantry, a party led by Rafferty (91) investigated the route from Valdez to Copper Center on the Klutina River. His party camped for several days at Copper Center. He described the mosquito situation at that time (June 9-13) as follows:

The long-expected pests, the mosquitoes, were out in full force during the stay at this camp, and the men were compelled to wear veils day and night, with gloves to protect the hands. The ferocity of these mosquitoes I regard as something remarkable. The species found here is not the large, singing sort seen in the States, but a small, silent, business-like insect, sharp of bill, who touches the tender spot in a surprisingly short time after alighting. After making their appearance they never left the expedition for a day.

The conditions described by these early travelers do not prevail in all parts of Alaska with equal intensity, nor are they always as severe in the same locality from year to year. However, Stefansson (101) after many years of travel and ex-

<sup>1</sup> Now with the Department of Entomology, Cornell University, Ithaca, N.Y.

<sup>2</sup> Italic numbers in parentheses refer to Literature Cited, p. 81.

ploration in the North considered mosquitoes one of the principal obstacles to the development of this region.

The first information on the species of mosquitoes that are such a severe pest in many places in Alaska may have been obtained by Trevor Kincaid (Coquillett 20) of the Harriman Alaska Expedition in 1899. He collected large numbers of insects, including two species of mosquitoes. Mosquito collections have also been made by J. S. Hine of the National Geographic's Mount Katmai expedition in 1917, as well as by H. G. Dyar in 1917 and J. M. Aldrich in 1921.

The habits, biology, and methods of control of mosquitoes in Alaska were first investigated in the summer of 1931 in a cooperative project between the U.S. Bureau of Entomology and the U.S. Smelting and Mining Co. The investigations were carried on by Tulloch (106) at Fairbanks, Alaska. Fifteen species were collected in the area during the summer. Recommendations for control of mosquitoes affecting the men employed in gold-dredging operations there included burning of the dead vegetation to facilitate evaporation of partially covered pools, minor drainage, and spraying of breeding areas adjacent to the mining operations with diesel oil.

Additional information on the distribution, abundance, and species of mosquitoes in Alaska was obtained by Stage in 1943 (99). Chamberlin also added considerable information to our knowledge of Culicidae during 1943-45 (99). During 1956 in northeastern Alaska Ehrlich (9a) collected several species of mosquitoes not previously reported from beyond the tree line.

Studies of the biology and control of arctic mosquitoes were made for the U.S. Navy installations at Umiat, Alaska, by Jachowski and Schultz (75) and by Knight (80)

during 1947-48. Work in this area was carried on mainly during the summer and was handicapped by huge swarms of mosquitoes, which emerged after the spring thaw and persisted until the first frost. Four species were present. Neither fuel oil alone nor fuel oil and DDT gave satisfactory control in airplane applications against larvae, but DDT-fuel oil applications against adults markedly reduced the mosquito population for a few days.

The need for protective measures against the hordes of biting insects in the arctic and subarctic became more urgent with the increased military interest in these regions after 1941. As a result of a discussion of these problems by workers in the U.S. Department of Agriculture and the office of the Surgeon General, U.S. Department of the Army, a project was outlined by the former to obtain basic information for insect control. This project was approved by the Surgeon General in 1946, and the Department of Agriculture was designated as the responsible agency. Specialists were assigned from the various agencies concerned. Quarters and subsistence for the men and all supplies and equipment were furnished by the military except microscopes and a limited amount of similar equipment, which were provided by the Department of Agriculture.

An advance party of five arrived in Alaska on May 4, 1947. In all, 21 persons were employed on the project during 1947, and the number was increased to 40 during 1948. U.S. Air Force pilots were assigned as needed, and 19 enlisted men were attached to the project for varying periods during the summer. In 1949, 10 men carried on the work; pilots and several enlisted men were again assigned as needed. In 1950 the party was limited to six men, in addition to the plane pilots and four enlisted men.

The U.S. Public Health Service, which assigned several men to the project in 1948-49, has since maintained a permanent staff of three entomologists on mosquito and black fly problems in Alaska.

The personnel carrying on these investigations from 1947 through 1950 were principally entomologists, but climatologists, botanists, an aquatic biologist, and an equipment engineer were also included. The major effort was directed against mosquitoes, which are the most widely dispersed and troublesome pests in Alaska, but much time was also devoted to black flies. Most of these studies were carried on in May, June, and July, but during 1948 the work on some phases was begun in March and continued through September.

The work on mosquitoes was directed toward determining what species were present, which were the most important as pests, where they bred, and what could be done toward their control. To obtain this information, detailed biological studies were made of the mosquito

fauna, reared specimens were collected for taxonomic purposes, and experiments were conducted on the control of mosquitoes with ground and aerial equipment. The effectiveness of standard repellents against Alaskan mosquitoes was also determined.

The effect on mosquito larvae of DDT residues, which were left when larvae and adults were sprayed in previous years, was investigated in 1950. Further investigations of the effects of the residues were made by entomologists and other scientists from the offices of the Quartermaster General and the Surgeon General, U.S. Department of the Army, in 1951. This group also investigated the effectiveness and acceptability of clothing treated with insect repellents and the effectiveness of insecticidal fog-producing equipment.

The relationship of weather to mosquito abundance was also studied in Alaska by R. I. Sailer of the U.S. Bureau of Entomology and Plant Quarantine from 1951 to 1953.

## Mosquito Literature

The amount of literature on mosquitoes has become exceedingly large. Each year about a thousand references to various phases of the biology of mosquitoes and the diseases they carry appear in widely scattered publications. Probably no other group of insects has received so much study throughout the world. Some of the publications of especial interest to workers concerned with the mosquitoes of Alaska are given at the end of this handbook.

One of the early comprehensive books on the mosquitoes of the Americas was published by Dyar (27) in 1928. It deals with the distribution, biology, and taxonomy of mosquitoes on these two continents.

Matheson's handbook (85), revised in 1944, gives much information on the taxonomy and biology of the mosquitoes of North America, and it includes a discussion of their relation to human welfare and problems of control.

In 1948 Natvig (87) published an authoritative book on the biology, distribution, and taxonomy of the Danish and Fennoscandian mosquitoes. A number of the species of northern Europe also occur in Alaska.

In 1949 Bates (10) compiled voluminous facts on the biology and disease relationships of mosquitoes.

The taxonomy, biology, distribution, and medical importance of

North American mosquitoes are covered in an authoritative book by Carpenter and LaCasse (18), which appeared in 1955.

In 1959 Stone, Knight, and Starcke (102a) published a synoptic catalog on the mosquitoes of the world. This is a useful source of information on the synonymy and the world distribution of the species found in Alaska.

A textbook by Herms and Gray (63) is designed primarily for entomologists, engineers, and staff employees who are directing the activities of mosquito-abatement districts. It gives information on laws and agencies for mosquito abatement, education of the public, general principles of abatement

methods and techniques, abatement of disease vectors, and a host of related data.

The following periodicals will be of interest to students of Culicidae: *Mosquito News*, published quarterly by the American Mosquito Control Association at Albany, N.Y., and the *Proceedings*, published each year by the New Jersey Mosquito Extermination Association, the California Mosquito Control Association, the Florida Anti-Mosquito Association, and the Utah Mosquito Abatement Association. Articles on mosquitoes also appear in bulletins and reports of the U.S. Public Health Service and in various entomological, medical, and other scientific journals throughout the world.

## Economic Losses

Mosquito species found in Alaska are not known to cause disease. However, the huge numbers (fig. 1) present in many places and the se-

vere annoyance they cause are important economic deterrents to the development and progress of the State. The efficiency of all human



PN-808

FIGURE 1.—Mosquitoes resting on a man's back—typical of the mosquito problem that in some years may affect much of Alaska during June and July.

effort in any area where large numbers are present is greatly reduced by the necessity for "fighting them off" or for using bed nets, head nets, and other protective clothing. Losses in weight and milk production of livestock, as well as the ad-

verse effect on wild game, occur when large numbers of these pests are present. Alaska also loses much of its recreational value because of mosquitoes, and consequently the tourist trade is adversely affected.

## Mosquito-Control Organizations

Mosquito-control operations in Alaska in recent years have been carried on almost exclusively by the military for the protection of their personnel. However, agricultural areas and many small centers of population are not included in these control operations. As the State develops and the population increases, control agencies to handle such local problems will be necessary.

Local mosquito-control agencies are commonly called mosquito-abatement districts. Laws have been enacted to facilitate the organization of such districts. These laws vary considerably in the different States, but the most common is one whereby a district may be organized upon the petition of 5 or 10 percent of the legal voters of the area affected. After a public hearing, the board of trustees of the county in which the area is situated decides whether in the public interest a district should be formed, and if it so determines, it fixes the boundaries of the district. The district is governed by a board of trustees, whose members serve without pay. The board manages the affairs of the district, employs personnel, and determines the annual budget. The county board of su-

perisors levies a special tax to raise the funds required for this budget.

Mosquito-abatement districts in many States with different types of laws or without laws are organized under county or city supervision or under the direction of county health departments (see Herms and Gray 63).

In 1951 there were mosquito-control associations in New Jersey, Florida, California, Virginia, Utah, and Illinois (Stage 98). Since then one has been formed in Oregon and one in the Northeastern States. Each of these associations holds annual meetings, and most of them publish their proceedings, which contain valuable contributions on mosquito biology and control.

There is also the American Mosquito Control Association, which is international in scope and has over 1,200 members. It is a nonprofit professional association composed of entomologists, sanitary engineers, control officials, medical personnel, and laymen, who are charged with or are interested in mosquito control and related work. Annual meetings are held in various parts of the United States, usually conjointly with those of the State associations.

## Life History

Mosquitoes have diverse breeding habits, particularly in regard to the type of place they lay their eggs, but all have one characteristic in common—they live part of their

life in water and water only. It may be in a small tin can or in a vast tidal marsh.

Some species may be found in several kinds of water and others

only in restricted areas in certain types of breeding places. For example, *Aedes flavescens* is found only in unshaded flood plains, whereas many of the Alaskan *Aedes* species are found in a considerable range of open and semiwooded breeding places. Some genera such as *Aedes* lay their eggs on ground that may later be flooded, whereas others such as *Culex* and *Culiseta* lay them directly on the water surface.

Temperatures of air and water, alkalinity or acidity of the water, and associated shelter and vegetation affect the abundance and presence of most species. The species also differ in biting habits, longevity, and flight range.

The mosquito has a complete metamorphosis. There are four well-defined stages—the egg; the larva, sometimes called wiggler; the pupa, or tumbler; and the adult, or imago.

### EGGS

The eggs may be laid singly as with the anophelines, in rafts as with *Culex* and *Culiseta*, or in scattered groups of various numbers as with *Aedes*. In very warm weather the eggs of some species may hatch within 2 or 3 days after they are laid. However, in northern latitudes the eggs laid by *Aedes* in the late summer do not hatch until flooded the following spring. If not flooded the first season, they may remain viable for several years (Gjullin et al. 58). There is still some question as to whether northern *Aedes* eggs require a certain amount of drying and exposure to cold before they hatch or, as we believe, a low oxygen concentration (Gjullin et al. 51). A blood meal is considered necessary for the production of viable eggs, but exceptions have occurred both in the genus *Aedes* (Hocking 65) and *Culex* (Wray 115).

### LARVAE

All mosquitoes spend their larval and pupal stages in water, and most of them move freely about as aquatic insects. Without water these stages cannot survive for more than a few hours. The larvae of most species must come to the water surface for air, which they obtain through an air tube or other appendage located at the end of the "tail." The larvae shed their skins four times. The larval stage usually lasts from 4 days to 2 weeks, but some *Aedes* mosquitoes may remain as larvae for a month or more when the water temperature is just above freezing.

The food of mosquito larvae consists of microscopic plants and animals and organic debris. Some species prey on the larvae of other species, and some are cannibalistic. Barber (9) has reared larvae on pure cultures of various organisms, and Hinman (64) has suggested that materials in solution or colloidal suspension in the breeding water form a part of the larval food. We have reared several species of *Aedes* and *Culex* in the laboratory on ground dog food and blood albumin and also on yeast and powdered milk.

### PUPAE

With the fourth larval molt the pupal stage appears. The pupae move about by somersaulting. Their life is short and active. An excellent account of the emergence of an adult mosquito from the pupal stage is given by Marshall (84).

### ADULTS

Only the female mosquito has mouth parts adapted for bloodsucking. While the insect is biting, it injects a secretion that causes itching.

*Culex territans* feeds only on cold-blooded animals such as snakes and frogs. There are no records of *Culiseta morsitans* biting man. All the other true mosquitoes in Alaska feed on warm-blooded animals. Many of these species also feed on plant nectars.

The food of male mosquitoes consists of nectars and other plant juices, but not blood. In the laboratory we have kept alive both sexes of some species for long periods on raisins, fruit juices, and sugar solutions.

## Distribution

Despite the undisputed severity of the mosquito problem in Alaska, the problem is not of equal severity in all localities or in the same locality from one year to another.

Like all animals and plants, the distribution of the various mosquito species over an accessible area is determined by the suitability of the environment. Where marked differences of climate and topography prevail, it is to be expected that some species will thrive in one part and be reduced in number or entirely absent in another. Knowledge of these factors and how they function is necessary if the mosquito problem is to be handled intelligently.

In discussing the relative abundance and distribution of mosquitoes in different parts of Alaska, it is convenient to divide the State into four zones, which coincide with biotic provinces or Alaskan extensions of such provinces described by Dice (26) in 1943. These zones are shown in figure 2 and are defined as follows:

(1) *Sitkan*.—This zone includes that part of the Pacific mountain region from Cook Inlet to the southern tip of the Panhandle. It is a narrow strip of mountainous coast (fig. 3) with numerous adjacent islands. The mountains rise from 5,000 to 9,000 feet. Great glaciers fall from the mountains and often debouch directly into the sea. The climate is mild and over most of the Panhandle not greatly different from that of the Puget Sound area. Rainfall is high with an annual average in the extreme southeast of as much as 160 inches. Sitka spruce and western hemlock predominate in the forests.

The Cook Inlet area is an extension of the Sitkan zone but is in many respects intermediate between that zone and the interior. Extremes of temperature are more pronounced and annual rainfall rarely exceeds 20 inches. Black and white spruce are the principal forest trees, but such typical interior plants as larch and cattails are absent.

The mosquito fauna of the Sitkan zone is not greatly different from that of the coast of British Columbia. The pest problem in this zone tends to be local in character. High populations may be present on coastal flats and in forested valleys, but the problem does not differ greatly from that encountered along the coasts of Washington and British Columbia.

(2) *Aleutian*.—This zone encompasses that part of southwestern Alaska beyond the tree line. It is a continuation of the Pacific mountain region and includes the islands of the Aleutian chain. Summer and winter temperatures are moderate and annual rainfall is relatively high, but the almost continuous cold fog and high winds during the summer prevent the growth of trees and give to the zone an aspect similar to that of the arctic coast. However, grasses rather than typical tundra vegetation form the prevailing ground cover (fig. 4). The biota is reduced and mosquitoes appear to be absent or present in very small numbers over most of this zone.

(3) *Hudsonian*.—This zone comprises most of interior Alaska. It is bounded on the north by the Brooks Range and on the south by the Coast Ranges. On the west it is separated from the Bering Sea coast by a narrow strip of tundra. The zone is a continuation of the northern coniferous forest that extends the full width of Canada and is drained by the Kuskokwim and the Yukon Rivers. The best agricultural land in Alaska is found in the Tanana Valley, which is part of the Yukon watershed.

The climate is dry with extremes of temperature—a long cold winter and a short hot summer. Temperatures in the



PN-809

FIGURE 2.—Biotic provinces of Alaska, adapted from Dice (26), superimposed on vegetation zones, adapted from a map compiled by Sigafos (*in* Hopkins et al. 70, p. 136).

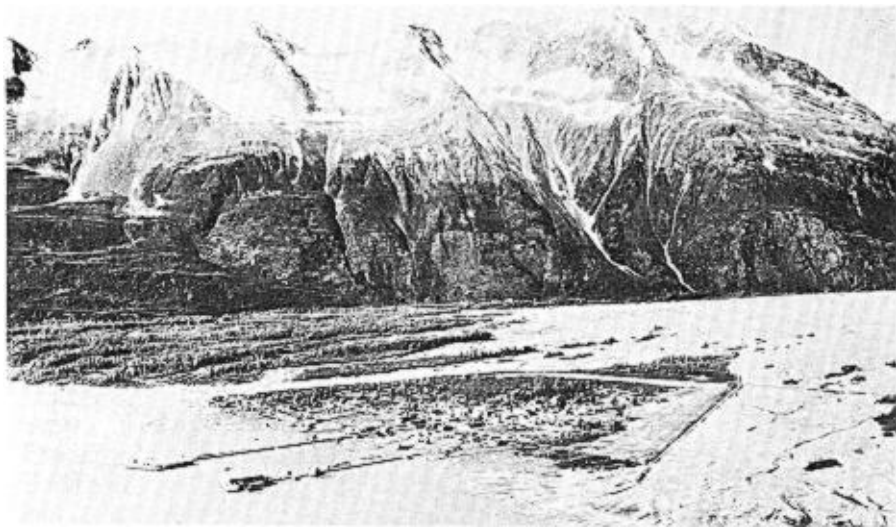

PN-810

FIGURE 3.—Aerial view of Valdez, showing characteristic topography of the south-central Alaskan coast.





PN-811

FIGURE 4.—West coast of Kiska, showing grasses typical of the Aleutian zone. (Photograph by Ales Hrdlicka, 1936.)

high 80's are not uncommon in July, and during midwinter the minimum readings may remain between  $-40^{\circ}$  and  $-60^{\circ}$  F. for several days. The average precipitation is about 12 inches.

In undisturbed areas much of the land is covered with black spruce bogs, commonly referred to as muskeg. The forests are seldom high or dense, and they enclose large areas of sedge (*Carex*) and grass (usually *Calamagrostis*) meadows, which are marshy during part of the summer (fig. 5). Drainage is characteristically slow, at least in part because of the permafrost throughout most of the zone. Poor drainage and low evaporation during the long winter account for the general prevalence of bogs and swamps.

The mosquito problem reaches its most serious proportions in this interior zone, for though mosquitoes may be as numerous on the arctic slope, fewer people are concerned. In some years troublesome populations may be hard to find, but during other years a pest population may cover thousands of square miles.

Following Dice's (26) definition of a biotic province, areas above the timber-

line in the Alaska Range, as well as in the smaller mountain ranges of central Alaska, are zonal subareas of the Hudsonian zone. So far as mosquitoes are concerned, it seems best to treat these tundra inclusions as extensions of the Eskimoan zone, although there may be noticeable differences in relative abundance of the species present, as well as a tendency toward greater diversity of kinds.

(4) *Eskimoan*.—This zone includes the area to the north and west of the Hudsonian zone and lies beyond the tree line. Drainage is to the Arctic Ocean and the Bering Sea. Extremes of temperature are not so great as in the interior. The summers are generally shorter, and cold, foggy weather is more prevalent. Rainfall is low; the average for much of this area is below 10 inches and that at Point Barrow only a little more than 4.

The nearest approach to trees is shrubby willows and alders, which in some favored localities reach a height of 5 to 8 feet. The ground cover consists of a thick continuous mat of heath, prostrate willows, sedges, mosses, lichens, and

grasses, and it is generally referred to as tundra (figs. 6 and 7). The surface is rough, spongy, and usually waterlogged. Frozen soil is seldom more than 8 or 10 inches beneath the surface even in late summer.

Mosquitoes are perhaps more numerous than in the forested interior, though fewer species are represented. Year-to-year fluctuation appears to be less, probably because even poorer drainage and lower evaporation tend to minimize yearly dif-



PN-812

FIGURE 5.—Tanana Valley near Nenana, showing marsh pools in the center background.



PN-813

FIGURE 6.—Tundra near Teller, showing lighter areas covered with cottongrass bloom.



PN-814

FIGURE 7.—Tundra 5 miles south of Kotzebue. The alder bushes in the foreground attain a maximum height of 3 feet.

ferences in rainfall. The tundra-inhabiting species exhibit greater tolerance to wind and low temperature than the mosquitoes of the interior. Frequently it is necessary to wear a head net over a parka in order to work or move about the country in relative comfort.

These four zones reflect prevailing patterns of climate, which determine the association of species found there. Since climate is a measure of average weather conditions taken over a long period of time, it would be surprising if year-to-year differences in weather did not have a marked effect on the mosquito population. Such an effect has, in fact, been demonstrated<sup>3</sup> and is discussed below under Abundance.

Maps 1-12<sup>4</sup> show the known distribution in Alaska of the 27 species that have been collected there. The records are based on studies that

were obviously concentrated along the few highways and at localities easily reached by air or river boat. These localities are so widely scattered that only the most general inferences may be drawn from the records. When these maps are compared with figure 2, it is apparent that although most records for any one species are confined to one zone, most species have been recorded from two, and some from all but the Aleutian zone. In general, the distribution shows a close relationship to the tree line. Actually this relationship is closer than indicated by the maps, which are drawn at too small a scale to show many islands of tundra that are included in figure 2 and map 9 as forested, or to show the sinuous bands of forest that follow stream courses for many miles into the typical tundra.

## Abundance

Records of mosquito conditions at Fairbanks for 1929-31 and 1947-53 show that pest populations of se-

rious proportions were present during 1929, 1948, and 1949. During the remaining 7 years the mosquito problem was not materially different from that to be expected in uncultivated areas of the Eastern

<sup>3</sup> Unpublished data of Alaska Insect Control Project.

<sup>4</sup> See Appendix, p. 87.

United States. The Fairbanks data, supplemented by similar data covering 1951 and 1953 for the central Alaskan localities of Fort Yukon, Nenana, and Tanana, all show that each summer of unusual mosquito abundance has been preceded by a period of above-normal precipitation.

That this is true is not surprising, for the species of greatest pest importance are known to develop in temporary pools formed from melting snow and ice, and water must remain in these pools for the period required for mosquito development.

Under the climatic conditions of central Alaska, snow ordinarily accumulates from October through April. At breakup, which usually occurs during early May, the snow melts and forms innumerable pools, the duration of which is determined by (1) the amount of accumulated snow, (2) the moisture content of the soil at the time of the freezeup, and (3) the rate of evaporation and replacement during May and June. The last factor appears to be the least important, for May and June are months of consistently low rainfall and high evaporation. By contrast, the first two factors are extremely variable and may combine to give an exaggerated effect or tend to cancel each other. Thus, above-normal snowfall may thaw at breakup and be lost in abnormally dry soil, with the consequence that few mosquitoes are produced.

Present evidence indicates that the abundance of mosquitoes is more uniform from year to year at tundra localities than in central Alaska. Umiat is known to have had a severe mosquito problem each summer from 1947 until 1952. Yet there is ample evidence that pest populations are not present every year at all tundra localities, for the population at Umiat was not troublesome in 1953 and few mosquitoes were present in 1951 at Teller, where they were abundant in 1953.

In addition, local residents of Kotzebue, Teller, and Nome have reported that, although troublesome mosquito populations are present in most years, there are summers when few mosquitoes are seen.

Presumably the more constant year-to-year abundance of mosquitoes in the tundra areas of western and northern Alaska is the result of reduced evaporation during the short cool summers. One effect of reduced water loss would be the averaging out of unusual departures from normal precipitation, and thereby greater uniformity of conditions favorable to mosquito development would be assured in both a regional and a year-to-year sense.

### PREDICTING ABUNDANCE

Ability to predict mosquito abundance in advance of adult emergence has definite and rather obvious advantages. Even a month's advance information would permit improved coordination of control programs and distribution of supplies to areas of greatest need. It would also be advantageous if mosquito conditions could be anticipated before a work crew or survey party is sent into a remote area. Sometimes it might be desirable to plan the work so it would not coincide with the season of adult activity, or the work might be done at an alternative locality where no mosquito problem is expected that season.

Present data<sup>5</sup> indicate that reasonably accurate predictions of mosquito abundance can be made for those localities in central and arctic Alaska where weather records have been maintained long enough to provide reliable average

<sup>5</sup> SAILER, R. I., REGNIER, A. V., and MCGUIRE, J. U. USE OF PRECIPITATION DATA FOR PREDICTING MOSQUITO ABUNDANCE IN ALASKA. Unpublished report of work conducted with the cooperation of the office of the Surgeon General, U.S. Department of the Army, and assistance of the Arctic Institute of North America.

annual precipitation values. Two years' observations at three localities in central and two localities in arctic Alaska have shown that abundance of mosquitoes is correlated with departure from normal precipitation, and that the best correlation is found when departure is based on a 36-month period preceding May 1 of the season for which predictions are to be made.

Presumably the 36-month precipitation interval is necessary in order to account for soil-moisture conditions preceding the last winter's snow accumulation. The greater effect of precipitation received during the immediately preceding winter and summer on mosquito abundance makes it necessary to divide the 36 months into summer periods,

which include the months of May through September, and winter periods, which include the months of October through the following April. Weighted values must then be assigned to departure from normal precipitation for each of the three summers and three winters. The scheme of weights that provided the best correlation with observed abundance was 3-1-3-1-4-4.

Figure 8 shows the results of the observations made at the five Alaskan localities during the summers of 1951 and 1953. The counts shown were based on the number of mosquitoes captured in eight 180-degree sweeps with a 15-inch Ward's professional insect net, four sweeps taken on the lee and four on the windward side of the ob-

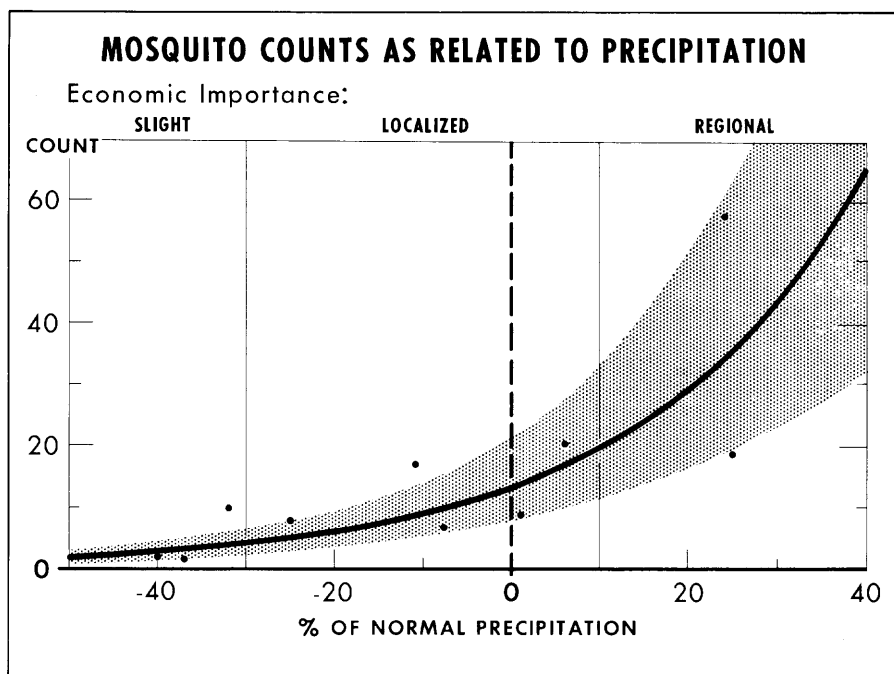

FN-815

FIGURE 8.—Regression of mosquito counts on departure from normal precipitation for 36 months, computed as six consecutive summer and winter intervals, assigned weights of 3-1-3-1-4-4. Vertical sections labeled slight, localized, and regional indicate the economic importance of mosquito populations expected to be prevalent under corresponding ranges of departure from normal precipitation. Based on data obtained in 1951 and 1953 at Tanana, Nenana, Fort Yukon, Kotzebue, and Teller.

server. The first sweep was made at the knee and the fourth at shoulder level. Counts were made hourly at a sheltered site and at a site exposed to the wind. Each count was preceded by a 5-minute period, during which meteorological observations were made. This provided a standard exposure period, during which mosquitoes were attracted to the observer. At no time was a repellent used.

So far as possible the observation period at each locality included 24 hours of optimum conditions for mosquito activity. To minimize the effect of transient weather conditions on mosquito activity, the 10 highest counts obtained at each locality were averaged. On the chart the average count for each locality for each year was plotted against the weighted departure from normal precipitation for that locality and year.

Using the 3-1-3-1-4-4 scheme of weights, the precipitation departure equals

$$\frac{3f+1e+3d+1c+4b+4a}{16}$$

where  $a$  equals actual departure from normal precipitation for the immediately preceding winter and  $b$  for the preceding summer. The remaining letters represent the other preceding winter and summer data in seasonal sequence to the beginning of the 36-month precipitation period.

The regression line shown in figure 8 was fitted to the data by the least squares method. The shaded area on either side of the line represents the calculated 95-percent confidence limits indicated by the available data. The regression line becomes straight when placed on a semilogarithmic scale.

The actual value of this effort to correlate mosquito abundance with precipitation will depend on how accurately the correlation can be used to predict populations of slight, localized, and serious re-

gional economic importance (fig. 8). The regression indicates that at a locality where the 36-month weighted departure is more than 30 percent deficient, men should be able to live and work in the field with little prospect of mosquito annoyance. If the departure is between 30 percent deficient and 10 percent excess, complete protection from mosquitoes will be required in some localized areas. These areas will become more numerous and larger as the departure approaches the upper limit. Above 10 percent excess the mosquito-infested areas fuse, and an evenly distributed pest population may cover hundreds of square miles.

Limited experience obtained from predictions made for several localities in the summer of 1956 suggests that an early breakup followed by a prolonged period of above-normal temperatures may cancel the effect of excess accumulated precipitation, with the result that few mosquitoes are produced at a locality where a severe outbreak would otherwise be expected. However, it seems doubtful that a late breakup and cold spring would result in a serious mosquito problem where a population of little consequence had been expected. Data supporting this contention are lacking, but there is no evidence of a general hatch of *Aedes* eggs in pools formed as a result of spring rains. Furthermore, abnormal rainfall would be required to maintain such pools long enough for larval development to be completed. If further experience confirms these views, errors in prediction will generally be in the direction of fewer mosquitoes than expected.

## EFFECTS OF WEATHER ON MOSQUITO ACTIVITY

Weather is the paramount factor affecting adult activity, even though the northern mosquitoes are remarkably well adapted to their rig-

orous environment. Of the various elements of weather, temperature is the most important, for during a period of 24 hours the mosquitoes are commonly subjected to temperatures both above and below those at which flight activity normally occurs.

With the possible exception of *Culex territans*, all species are crepuscular; however, this habit is modified by light conditions peculiar to high latitudes. Periods of greatest activity tend to coincide with twilight, the highest peak occurring in the evening and a lower peak in the morning. In latitudes north of the Panhandle where there is no complete darkness during the mosquito season, the drop in activity between the peaks coincides with the rapid fall in temperature that occurs during the short period when the sun is below the horizon. Over much of the area north of the Arctic Circle the effect of temperature is even more pronounced, although the sun does not set.

During favorable weather, mosquito activity on the tundra is more nearly continuous than in central Alaska, building up from a low of near zero between midnight and 2 a.m. to a peak between 8 and 11 p.m. Periods of calm, cloudy weather during the day are usually accompanied by increased activity. However, any prolonged cloudiness results in lowering the temperature, which soon falls below the threshold of activity.

At Kotzebue and Teller, periods of intense activity and relative freedom from mosquito annoyance follow a pattern that must be characteristic of the western seacoast. This pattern is controlled by a cyclic kind of weather, whereby 2 or 3 warm, fair days are followed by a week or more of cold, wet, windy days.

Although the factors affecting the activity of the adult female mosquito are well established, they

never function independently, and their effects in combination are often very subtle. The factors having the greatest effect are temperature, light, wind, saturation deficiency, lapse rate, and pressure change.

*Temperature.*—Pratt (90) found in his study near Fairbanks that most activity occurred between 45° and 80° F., with 60° approximately optimum. Jachowski and Schultz (75) reported similar findings for the arctic species at Umiat. Unpublished data<sup>6</sup> from Kotzebue and Teller show considerable activity at 42° and some at 40°. It is likely that factors other than temperature suppress activity above 80°, for at such times the sun is usually bright, the saturation deficiency is high, and a moderate wind may be blowing.

*Light.*—Direct correlations of activity with light are difficult, because other factors such as temperature and saturation deficiency are closely related to light. Nevertheless, most workers have been impressed by a daily rhythm of activity, which may be suppressed or even displaced by combinations of adverse or favorable factors other than light. If other factors are constant, counts on which activity is based average highest at a light intensity approaching twilight conditions.

*Wind.*—In central Alaska, mosquito activity subsides abruptly at wind speeds above 2 miles an hour and drops to zero at about 5 miles per hour. At tundra localities the arctic species are not noticeably affected by wind at speeds below 5 miles per hour, but begin to disappear when the velocity reaches 7 miles per hour. If other conditions are favorable, a few will persist even at a velocity of 10 miles per

<sup>6</sup> Report by R. I. Sailer, A. V. Regnier, and J. U. McGuire.

hour. Wind velocities appear to have an exaggerated effect when temperatures are near the upper and lower threshold values. At low temperatures this effect has been observed at Kotzebue and Teller, where considerable activity was observed at 43° to 45° F., but only if the wind velocity was below 1 mile per hour. Hocking et al. (68) point out that at high temperatures greater wind velocity increases evaporation and may affect mosquitoes in the same way as high saturation deficiencies.

*Saturation deficiency.*—Numerous attempts, including that of Pratt (90), have failed to show a clear correlation between relative humidity and mosquito activity. Yet all who have observed mosquitoes in the field agree that moisture must play an important role. This discrepancy is easily explained, for relative humidity is not a reliable measure of the capacity of air to hold moisture. When Hocking et al. (68) converted their humidity data to saturation-deficiency values, they were able to demonstrate a correlation with activity. However, the effect appeared to be delayed, with attack figures rising shortly after a fall in saturation deficiency and falling shortly after a rise.

*Lapse rate.*—Lapse rate is a measure of rate of temperature change from the ground level up. Pratt (90) found that mosquito activity was greatest during inversion conditions when the surface temperature was below 45° F. at the 3-foot level. With more extreme inversion conditions when the temperature at 5 feet was below 45° and warmer temperatures were above head level, no mosquitoes were found at body level, but they were seen flying in the warmer air overhead.

*Pressure change.*—Haufe (61) in laboratory experiments with *Aedes aegypti* (L.) found changes in atmospheric pressure to be an important factor in determining flight activity, provided the mosquitoes were first acclimated for 3 to 6 hours to a particular level. When the pressure was above 735 mm., decreasing the pressure was more stimulating to flight than increasing the pressure; whereas when it was below 735 mm., the opposite was obtained. Although field data concerning the northern species of *Aedes* are still lacking, failure to consider pressure change as a factor may explain some discrepancies in past attempts to correlate mosquito activity with meteorological data.

## Biology

### LARVAL HABITATS

When compared with the more temperate parts of the world, Alaska has noticeably fewer kinds of habitats in which mosquito larvae can live. Tree holes are an example of a missing habitat. No doubt such water-containing cavities exist in southeastern Alaska, but over the rest of the State they are absent either because the trees are small or because of frost action. With the exception of *Culiseta*, no species are known to breed in artificial containers.

The one-generation habit is common to all species, though at Anchorage a small second hatch of several species of *Aedes* has been observed during August after heavy summer rains. The species of greatest pest significance hatch within a few days after the spring breakup, or as soon as the snow or ice has thawed from the bottom of the pools. Most of the pools are temporary and originate from melting snow.

A practical system of classifying larval habitats is one based on the



degree of pool permanency, for to a great extent this factor determines other pool characteristics such as vegetation type, as well as presence and abundance of predators. Pool types may be characterized as temporary, semipermanent, and permanent.

*Temporary.*—These pools of snowmelt origin normally are dry 4 to 5 weeks after the spring breakup (figs. 9 and 10). They are found in widely different locations and support a variety of emergent and covering vegetation. The most important pools to the mosquito problem are those in *Carex* or *Calamagrostis* marshes and in *Sphagnum*-heath bogs. The marshes are shallow and vary in size from a few square yards to many acres. In central Alaska they are interspersed throughout the spruce and birch forests of lowland or level country. The flats along the southern coast include large areas that are covered with *Myrica-Carex* marshes.

*Sphagnum*-heath bogs commonly support stands of scrubby black spruce and form the muskeg so characteristic of the subarctic region. Except for deep potholes or ponds, both marshes and muskeg are largely dry during the last part of the summer.

Few predators are found in temporary pools.

*Semipermanent.*—These pools or ponds that are formed from snowmelt are maintained to some extent by seepage or a high water table. In normal years the pools are dry for at least a short period during July or August. *Carex rostrata*, *Potentilla palustris*, and *Equisetum fluviatile* are among the plants most often associated with pools of this kind (fig. 11). On the tidal flats (fig. 12) *Triglochin maritima* and *Scirpus paludosus* are indicative of the semipermanent condition (fig. 13). Such habitats are numerous in river valleys where there are many oxbow lakes.



FN-816

FIGURE 9.—Temporary pools in *Myrica-Calamagrostis* marsh near Fairbanks, where *Aedes intrudens*, *communis*, and *punctor* were collected.



PN-817

FIGURE 10.—Temporary pools hidden in *Calamagrostis* marsh near Anchorage.



PN-818

FIGURE 11.—Semipermanent pool near Anchorage, where *Aedes excrucians* and *fitchii* larvae were numerous.

Predators are prevalent in semi-permanent pools. Chaoborids, dytiscids, and *Callicorixa* (Corixidae) are often present in numbers sufficient to greatly reduce the population of mosquito larvae.

*Permanent.*—These ponds and lakes normally contain water through the summer (figs. 14, 15). *Lemna*, *Ranunculus*, and *Utricularia* are common, and *Carex aquatilis* often forms an emergent cover.



PN-819

FIGURE 12.—Eagle River Flats, a tidal marsh near Anchorage.



PN-820

FIGURE 13.—Semipermanent pools on Eagle River Flats near Anchorage, where *Aedes flavescens* larvae were found. These pools were seldom more than 2 inches deep and nearly continuous over the marsh.



PN-821

FIGURE 14.—Permanent pond near Fairbanks. *Culiseta alaskaensis* and *Aedes excrucians* are the predominant species.



PN-822

FIGURE 15.—Permanent pond near Anchorage. Habitat of *Anopheles earlei* and *Culex territans*.

Predators are abundant. Odonata naiads and dytiscid larvae and adults are always present in large numbers.

### Habitat Preferences and Relative Economic Importance of Species

From data obtained in 1948 by the Alaska Insect Project, the species have been tabulated according to the kinds of pools utilized as larval habitats. The percentages shown in table 1 are estimates based

on the number of times species were collected from one or more of the pool types and on their relative abundance.

Such an arrangement, based as it is on relative permanency of the pools, is unsatisfactory in several respects. It would be possible, and sometimes desirable, to establish additional divisions based on such factors as shade, presence or absence of vegetation, and kind of emergent or covering vegetation. There is also a marked tendency for species

TABLE 1.—*Species of mosquitoes arranged according to kinds of habitats from which larvae have been collected in central and arctic Alaska and their relative economic importance*

Species	Percentage of species collected in different kinds of pools			Relative economic importance <sup>1</sup>	
	Temporary	Semipermanent	Permanent	Central Alaska	Arctic Alaska
<i>Aedes intrudens</i> .....	100			1	
<i>canadensis</i> <sup>2</sup> .....	+	+		3	
<i>implicatus</i> .....	80	20		4	4
<i>communis</i> .....	70	30		2	2
<i>punctor</i> .....	70	30		1	2
<i>hexodontus</i> .....	60	40		3	1
<i>impiger</i> .....	60	40		3	4
<i>diantaeus</i> .....	50	50		6	
<i>cataphylla</i> <sup>2</sup> .....	+	+		6	6
<i>pionips</i> .....	40	60		2	
<i>nigripes</i> <sup>2</sup> .....	+	+		6	4
<i>pullatus</i> <sup>2</sup> .....	+	+		3	
<i>cinereus</i> .....	30	70		4	
<i>stimulans</i> .....		100		2	
<i>flavescens</i> .....		100		3	
<i>riparius</i> <sup>2</sup> .....				6	
<i>excrucians</i> .....		70	30	2	
<i>filchii</i> .....		70	30	4	
<i>aboriginis</i> <sup>2</sup> .....		+		6	
<i>deticus</i> .....		60	40	6	
<i>Culiseta alaskaensis</i> .....		80	20	2	
<i>impatiens</i> .....		80	20	2	
<i>incidens</i> <sup>2</sup> .....		+	+		
<i>morsitans</i> .....		70	30	5	
<i>particeps</i> <sup>2</sup> .....				6	
<i>Culex territans</i> .....		60	40	5	
<i>Anopheles earlei</i> .....		40	60	4	

<sup>1</sup> 1, Widely distributed, a pest species during years of unusually high abundance; 2, widely distributed, locally troublesome, especially during years of low abundance; 3, restricted distribution, but abundant under certain ecological conditions; 4, widely distributed, but not in large numbers; 5, widely distributed, but not known to bite man; 6, rare species.

<sup>2</sup> Data absent or too scanty to generalize. Plus marks indicate that the species has been collected in a particular pool type.

that commonly develop in temporary pools in central Alaska to utilize semipermanent pools in areas beyond the tree line. The explanation of this phenomenon may be concerned with the relative scarcity of predators in the tundra pools.

A well-marked succession of species based on the time of peak emergence generally follows the order in which they are listed in table 1, beginning with those that develop entirely or mainly in temporary pools and ending with those that utilize semipermanent or permanent pools as larval habitats. The time during which emergence of a species may occur becomes shorter toward the north or in any direction toward the tree line, and species succession is more clear cut. The *Culiseta* species, as well as *Anopheles earlei* and *Culex territans*, which are at or near the end of the succession, all overwinter as adults.

### Water Temperature of Larval Habitats

Hatching of mosquito eggs, at least of those species developing in

temporary pools, occurs as soon as the ice over the bottom of the pools melts. In shallow pools and in the presence of bright sunlight this may happen before the air temperature has reached or passed 32° F. Subsequent to thawing, the pools often freeze solid without injury to the newly hatched wigglers.

It is a common conception that if ice is present in a small pool, the water temperature cannot exceed 39.2° F. If this were true, some species of mosquitoes would complete most of their development at temperatures of less than 40°. Through detailed studies of vertical and horizontal temperature gradients, Pratt (90) was able to show that development actually occurs at a much higher temperature. As illustrated in figure 16, marked temperature gradients exist within a pool during periods of sunlight, and water in one part of this pool may be well above 50° even though ice is present. Larvae were always found congregated in the warmest water. No larvae were found in deep pothole pools in which the water never exceeded 40°.

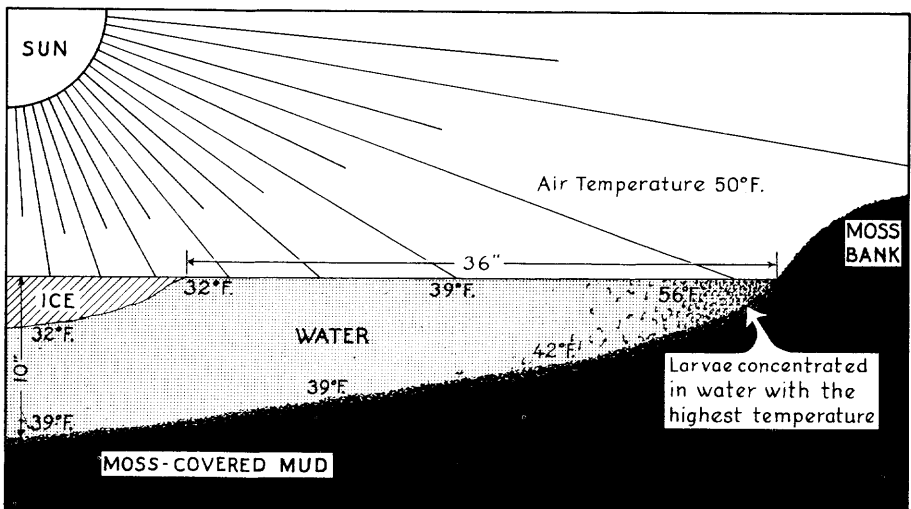

PN-823

FIGURE 16.—Diagram of a pool in which mosquito larvae are developing, showing temperature gradients during a warm, sunny day when ice is still in the pool.

## ADULT FOOD HABITS

Most discussions of mosquito feeding habits are concerned with the bloodsucking activities of the females. Actually, plant juices and nectars must form a preponderance of the food consumed by mosquitoes. Males are restricted to such foods, and females apparently seek blood meals only as a source of nitrogen needed for egg production.

Hocking et al. (68) presented evidence that feeding on nectar is a universal habit among females of the arctic and subarctic species at Churchill, Manitoba. The tremendous number of mosquitoes in many arctic or subarctic areas in contrast to the negligible population of vertebrates has roused speculation that these species may not require a blood meal in order to produce eggs. Beckel (12) obtained laboratory evidence that *Aedes communis* females were able to produce viable eggs when fed only on sucrose or raisins. Furthermore, Beckel could not induce *communis* females from the Churchill area to take a blood meal in the laboratory, nor were positively identified females observed to take blood meals in the field. Neither did he find evidence of flight-muscle autolysis such as Hocking (67) found in specimens of morphologically similar *communis*. In any event, there is clear evidence that at least some of the arctic *Aedes* species do not require blood for egg production. Undoubtedly the smaller vertebrates such as birds and their nestlings, as well as field mice and lemmings, form a larger source of blood than might be suspected. In a population like that studied by Hocking, resort to muscle autolysis as a source of nitrogen may be a secondary response that occurs only after the females have failed to obtain a blood meal within a prescribed time.

Females of *Culex territans* and *Culiseta morsitans* are not known to bite man or other warm-blooded animals. *C. territans* is known to feed on frogs.

Considerable research has been done recently on factors that attract female mosquitoes to a host. Hocking (66) has provided a summary and bibliography covering this work. Evidence indicates that temperature, moisture, and carbon dioxide are the principal attractants for the northern mosquitoes. As would be expected, these factors are most effective when functioning in combination. Light colors have been found to be less attractive than dark colors to some species, but this order of preference is reversed for others.

## LONGEVITY

The adult life span of the northern *Aedes* species is probably not more than 8 weeks in central Alaska and considerably shorter beyond the tree line. Very likely the longevity varies from year to year because of different weather conditions. The bloodsucking activity of the females serves as a partial clue to longevity. In the Fairbanks area pest populations subside rather abruptly about a month to 6 weeks after peak adult emergence.

In those species of *Anopheles*, *Culex*, and *Culiseta* where the females overwinter, it is likely that many individuals have an adult life of at least a year. However, the males live only until cold weather.

## FLIGHT RANGE

There is little information on the flight range of mosquitoes in Alaska. A large-scale test to control mosquito larvae near Fairbanks (Travis et al. 104) showed that adult mosquitoes penetrated to the center of a 100-square-mile area, in which all larvae had been killed, within 3 days after they had

emerged in adjacent untreated areas. However, when the same area was sprayed to control adults, infiltration was sufficient to require another treatment in about 2 weeks. If such movement is typical of untreated areas and continuous through a 6-week period of activity, such a population might disperse a distance of 25 to 50 miles.

Several factors undoubtedly affect the movement of mosquitoes. One of the most important is the habits of the different species. Such a species as *Aedes cinereus* is seldom found except in vegetation near its breeding place. In the only large-scale study undertaken on the dispersal of a subarctic species, Jenkins and Hassett (77) released 3 million radioactive adults of *Aedes communis*. During the first week no specimens were taken more than 600 feet from the point of release, and after a month only one had been recovered from as far as 5,000 feet.

The tundra is characterized by a comparative absence of barriers to free movement. This factor, combined with the ability of *Aedes hexodontus* and *nigripes* to fly in wind moving at a velocity twice that tolerated by woodland species, provides ample reason to expect the flight range of these arctic mosquitoes to exceed that of any species found in central Alaska.

The widely held view of local residents that mosquitoes are carried great distances by the wind has never been confirmed. On the contrary, mosquito activity has been repeatedly observed to cease whenever the wind velocity exceeds the flying speed of the mosquitoes. Flight activity of the kind that would promote dispersal has been observed<sup>7</sup> at times when the wind velocity was about 1 mile an hour and when a pronounced temperature inversion caused the air tem-

perature near the ground to be below that at which mosquitoes are normally active while the air at treetop level was still warm.

The periods of most intense mosquito activity were found by Pratt (90) to coincide with times when moderate inversion conditions were present. If dispersal activity is correlated with inversion conditions, it should be possible to predict the principal direction of such movements in a given area, for air movement at such times usually follows a drainage pattern determined by the topography.

## MATING

Except for the dissenting views of Nielsen and Greve (88), authorities generally agree that mating in mosquitoes is almost invariably associated with the swarming habit of the males. Although this habit appears to be common to all the Alaskan species, observations by Frohne and Frohne (39, 41) and others show that the time and place of swarming may depend on the species.

The Frohnes observed swarms of *Aedes punctator* containing hundreds or even thousands of males and noted that matings in a swarm occurred at rates of 1 to 10 per minute and rarely as high as 150 per minute. They also reported watching swarms of *Aedes communis* between 8 and 9 p.m. on June 16, 19, 20, and 21. The swarms occupied the same site about 8 to 10 feet above the ground, in what was described as a "glade recess." On June 20 at 9:30 after *communis* ceased swarming, they saw a swarm of *Aedes excrucians* form at the same site, but the focus of this swarm was 10 to 20 feet above the ground.

All Alaskan species for which records are available swarm in the evening except *Culex territans*. It was observed by the Frohnes to

<sup>7</sup> See footnote 3, p. 11.



swarm between 3:30 and 4:45 p.m.; however, they saw no mating.

jected to apparently identical field conditions.

### OVIPOSITION

Of the various biological aspects of Alaskan mosquitoes, perhaps least is known of their oviposition habits. It is known that the *Aedes* species lay their eggs in moist depressions, which are subject to flooding at the time of the spring break-up. Eggs of the *Anopheles* species are laid on the surface of the water, and eggs from each deposition tend to clump together. The *Culex* and *Culiseta* species deposit rafts of eggs. Frohne (34) has shown that *Culiseta alaskaensis* and *impatiens* females are rather discriminating in their selection of oviposition sites, *alaskaensis* selecting small pockets in emergent clumps of dead *Carex* and *impatiens* ovipositing on open water devoid of emergent vegetation. Very likely the *Aedes* species are also able to detect and lay their eggs at sites suitable for the larval development of their particular species.

Eggs of some northern *Aedes* species remain viable (Gjullin and Yates 57) for several years. Water having a low oxygen content is important as a hatching stimulus for eggs of these species (Gjullin et al. 51). Additional factors must also play a part, since not all eggs hatch even though they are sub-

### HIBERNATION

According to Bates (10), there are four types of season cycles found among the life histories of mosquitoes. One of these types includes all the Alaskan species of *Aedes* and is referred to as the *A. cinereus* type of cycle, in which there is but one generation a year and hibernation is in the egg stage.

With one possible exception, the remaining Alaskan species—those belonging to *Anopheles*, *Culex*, and *Culiseta*—belong to a fifth type of cycle recently described by Frohne (34) and referred to as the *Culiseta impatiens* type. In this cycle fertilized females overwinter and there is but one generation a year.

*Culiseta morsitans* may overwinter in the larval stage and would thus fall in the *Anopheles claviger* type of cycle described by Bates.

The type of season cycle must have an important bearing on the distribution of mosquitoes in Alaska, for those species belonging to the *C. impatiens* type are rarely found beyond the tree line, except in mountainous areas where the tree line is determined by altitude. Probably these species require the sheltered habitats associated with trees as hibernating quarters for the adult females.

## Surveys of the Mosquito Problem

Adequate mosquito surveys and engineering surveys must be made if control measures are to give satisfactory results quickly and economically. Such surveys are often initiated by a few interested individuals who wish to learn whether their local mosquito problem can be alleviated or eliminated. If control appears to be feasible, then community action is usually required in order to make arrange-

ments for operating funds and proper execution of the control program.

### MOSQUITO SURVEYS

Mosquito surveys must be made by competent entomologists. The entomologist must determine what species are present and learn as much as possible about their biology and their environment. He should

establish which species contribute to the problem and which are uncommon or do not bite man and his domestic animals. Surveys should extend some distance beyond the boundaries of the community for which a control program is being planned, for some species are known to disperse several miles. Under Alaskan conditions surveys need not be concerned with potential disease vectors but should concentrate on the few aggressive and abundant species.

In order to study biting habits and flight activity, the entomologist must be able to identify the adult mosquitoes and also the larvae, so as to associate them with the type of water or breeding area in which they occur. The larvae of some species live almost exclusively in permanent water and others only in temporary water; some prefer shaded pools and others only pools well exposed to the sun; some are found in polluted water or water with a large amount of decaying organic matter and others only in clear unpolluted water.

Unfortunately one entire mosquito season is not adequate for a complete entomological survey, as the species composition and abundance may vary considerably from year to year. Several years are often required before the entomological data are reliable. Fairly effective control operations can be started before the surveys are completed, but without reliable data, control may be erratic and result in the loss of public confidence.

Mosquito surveys may provide additional information of value to the control director. It is rather common for critics to maintain that control procedures are ineffective. If some reliable figures are available on the control of species and population densities, these can be used as proof of results. There is also a need for standard methods of observations, so that comparisons

can be made of progress over the years in each community.

Mosquito surveys normally include the collection and identification of both adults and larvae. In some areas outside Alaska useful information has also been obtained from egg surveys.

*Adult surveys.*—Several methods have been used to collect adult mosquitoes, but usually they include various types of hand and trap collections.

Hand collections of biting mosquitoes provide the simplest and most direct method of determining which are the troublesome species and the relative abundance of each. Such collections are usually made with a killing bottle.

The most useful procedure for making hand collections in Alaska is to select representative locations in the community where daily, weekly, or biweekly collections can be made throughout the season. A normal procedure is to stand or sit for 1 or 2 minutes at each location and collect mosquitoes as they alight to bite. Some standard collection time should be used, so that all data can be comparable. If mosquitoes are not too abundant, one person can collect in a killing bottle all those that land on the front of his trousers. If two people are working together, one can collect the mosquitoes alighting on the back of his companion.

When two or more persons are to make collections at different places, they should make some preliminary collections at one place to determine the relative attractiveness and dexterity of the different collectors.

Care must be taken in selecting the collection locations, as some species bite more freely in the bright sunlight and some in the shade, and many species bite more readily at dusk. The numbers will, of course, vary with the weather conditions.

A common hand-collecting method in some areas is to catch the mosquitoes in their daytime resting places, such as dark corners of buildings, under structures, in hollow trees, or in prepared resting places such as barrels and boxes. In Alaska the resting-place collections are not very useful.

Traps furnish data with the least personal bias, and some types of traps are more likely to capture rare species and males than are taken by hand collections. Traps are not known to be of any value for control. They serve only as a sampling device.

Several types of traps have been used. One of the most common is the New Jersey light trap. It has a light to attract the mosquitoes and an electric fan to suck them into a cyanide jar, where they are killed, or into a large cage if live mosquitoes are desired. Such a trap may be useful in southern Alaska, but it is of little value in the northern areas, since the nights are not dark. These traps have the additional disadvantage of capturing many other insects.

In tropical areas it is rather common to use traps baited with some animal such as a horse or a mule. Such traps have not been used in Alaska, but it is thought that they would be of little value.

A mechanical rotary trap has been used in Alaska with some success (Chamberlin and Lawson 19 and Stage and Chamberlin 99). It can be operated by a gasoline motor and therefore does not depend on electricity or darkness. Since it catches all insects that fly within its collecting range, the exact number of insects per cubic foot of atmosphere per time unit can be determined. Another mechanical trap used in Alaska is made by fastening a screen-wire cone on the fender of an automobile. With such a trap one can take continuous samples of mos-

quito populations while traveling down a road. Both of these mechanical traps have the disadvantage of damaging the specimens so that identification may be impossible. It may be possible to determine total mosquito counts but not the species.

In areas where mosquitoes swarm about people or domestic animals as they do in Alaska, it is possible to obtain a good population count by making a uniform number of swings with an insect net. For instance, if a net is swung back and forth quickly over a uniform distance and a uniform number of times, the number caught in each collection can be used as a population index figure (fig. 17).

A trap that is useful to check on the total number of mosquitoes emerging from a given location and on the species can be made by placing a cage covered with screen wire or mosquito netting in each of several breeding locations to capture the adults as they emerge.



PN-824

FIGURE 17.—Sweep-net method of obtaining a population count, showing the first of eight 180-degree sweeps taken from knee to shoulder height. Four sweeps are made on each side of the observer.

Such a trap gave useful information in Alaska.

*Larval surveys.*—The traditional way of making a mosquito survey is to locate the larvae by sampling various water accumulations with a white enamel dipper (fig. 18). Some workers prefer to insert a 2- or 3-foot-long stick in the handle. Considerable skill is required in the use of a dipper. Some larvae, especially the *Anopheles*, may be collected best by skimming the water surface, whereas other larvae may be more easily captured by submerging the dipper deeply and quickly. A little experience is necessary before one can dip successfully. It is common for one person to collect rather consistently more than twice as many larvae as another. With a little effort and experience, workers can be trained to obtain rather uniform numbers with their dips. Ordinarily larval

populations are expressed as the number of larvae per dip or, if the larvae are not numerous, the number per 10 dips.

Larval surveys serve to determine not only the species present but, even more important, the comparative abundance in the various water accumulations. They are used to show which areas should be treated with larvicides and which areas have no larvae or too few to justify the expense.

In larval surveys, records must be kept of the types of water in which the larvae are found. In Alaska *Anopheles*, *Culex*, and *Culiseta* are typically associated with permanent water, whereas most of the *Aedes* are typically associated with temporary water.

The timing of the larval surveys is extremely important. For instance, nearly all the Alaskan *Aedes* eggs hatch as soon as the snow and



PN-825

FIGURE 18.—Using a dipper to collect mosquito larvae in a semipermanent pool near Anchorage. *Aedes communis* and *punctator* larvae developed in marginal areas. Large numbers of *Culiseta impatiens* and *alaskaensis* emerged later from pools where water remained longest.

ice start to thaw in the spring, and in central Alaska nearly all larvae have matured by the first week in June. Surveys made after the first of June may show very few larvae present, and these are more apt to be the less numerous *Anopheles*, *Culex*, or *Culiseta*.

*Egg surveys.*—Although no egg surveys have been made in Alaska, several methods have been used to study the distribution of mosquito eggs in other areas.

The different egg-laying habits necessitate different types of survey methods. *Anopheles*, *Culex*, and *Culiseta* egg surveys have been made by skimming the water with fine strainers such as bolting cloth or by straining water through folded cheesecloth. The *Culex* and *Culiseta* egg rafts can be seen floating on the water. *Aedes* egg surveys have been made by sampling the soil where the eggs are laid.

Three types of mechanical devices have been used to sample *Aedes* mosquito eggs. One method uses a modified vacuum cleaner (Husbands 72) to pick up the eggs. The soil and debris are then removed with screens and the remaining soil is examined for eggs under a microscope. The other two methods employ a modified grain cleaner (Gjullin 49) or a series of three

concentric screen cylinders in a water bath (Horsfall 71) to remove the bulk of the soil from hand-collected samples.

A simple method to sample *Aedes* mosquito eggs is to take soil samples to the laboratory and flood them with water. As many eggs may have a resting state known as diapause, they may not hatch well except in the spring.

## ENGINEERING SURVEYS

Engineering surveys are most effectively made after the entomological information has been assembled, or they may often be made concurrently. The purpose of these surveys is to ascertain from the critical topographical features of the mosquito-producing areas whether control can include such permanent measures as water removal through drainage or fills or whether temporary control with insecticides is the only indicated method. The engineering survey must determine the extent and nature of the water accumulations and whether the water is permanent or temporary. It can be made by a sanitary engineer or a mosquito-abatement engineer in cooperation with an entomologist, or by an entomologist who is familiar with the engineering aspects of mosquito control.

## Methods of Mosquito Control

Mosquito control in the arctic and subarctic regions received almost no attention prior to 1940. Although the tremendous populations of mosquitoes were known to those who lived or worked in Alaska, it was not until 1947 that comprehensive studies were started by civilian and military organizations to appraise the problems and to investigate the practicability of controlling these pests.

As mosquitoes can fly several miles from their breeding places

(15, 100), there is often little that an individual can do to obtain adequate control. The most satisfactory program is provided when entire communities coordinate their efforts.

Since the midforties, when the organic insecticides first came into general use, mosquito control has become more and more complicated but at the same time more effective. Now, if control with insecticides is indicated, one must decide which of several insecticides, which formula-

tions, and which of the many complicated pieces of equipment to use (107).

A complete program for mosquito control today is directed not only against the larvae but also against the adults in and around buildings and in large areas. No satisfactory methods have been developed to control mosquitoes in the egg or pupal stage.

### CONTROL OF LARVAE

Mosquitoes can usually be controlled most easily and cheaply while they are in the larval stage. Two methods have proved useful—environmental control, which is more permanent, and control with insecticides, which is temporary (4).

#### Environmental Control

Wherever possible, the water in which mosquito larvae are found should be eliminated by drainage, fills, and manipulation of water levels (63). Drainage and fills are undoubtedly the most certain methods of eliminating mosquitoes, but the costs of such operations are high. Although these methods have been used successfully in many temperate and tropical areas, prospects for general use in Alaska are not promising. The usually large and inaccessible breeding areas, the permafrost, and the high water tables characteristic of much of the region impose severe limitations on control by drainage. The use of fills is even less practical. Where fills are made, care should be taken that they do not interfere with natural drainage, and all borrow pits should be opened to the natural drains. Drainage and fills are likely to be of use only in or near well-populated communities.

Drainage is accomplished by digging a series of ditches to remove the water from locations where mosquito larvae are found. For

this method to be effective, the water level of the breeding area must be higher than the natural drainage systems, such as streams, lakes, and the sea. If the breeding area is high enough, the ditches will either keep the land free of water or else carry any larvae into the natural drainage systems. In many communities road fills have blocked natural drainage, and in such locations large numbers of mosquitoes may be produced. The proper use of drainage culverts will correct the roadside water accumulations.

To be effective, ditching systems must be kept under annual surveillance and must be maintained. Some ditches will need cleaning every year or so, lest they become clogged and cause flooding that may produce more mosquitoes than in the unaltered breeding areas.

Mosquito control by manipulating water levels has proved satisfactory in many areas and may be of value in special locations in Alaska. A typical procedure is to construct dams across the outlets of lakes and ponds to hold the water level constantly high and thereby limit the area of marshland on which eggs may be deposited. Ditches may be dug along the impoundment margins parallel to the elevation contours to receive seepage and other water accumulations, which should then be drained into the main impoundment by way of secondary ditches. This method is most effective if the margins of the impounded area are steep, so that there is a minimum of shallow water, and also if they are free of vegetation.

An important aid to the control of mosquito larvae in impounded waters, such as the TVA water systems, has been the removal of submerged vegetation along the shore as well as within the main water area. Mosquito larvae do not survive long in open water that

is deep, free of vegetation, and subject to considerable wave action.

### Control With Insecticides

Where it is not feasible to eliminate mosquito-breeding places, the larvae may be controlled with insecticides. Although this method is only temporary, it has a more lasting effect in Alaska than in many areas. In warmer climates there may be several broods each season, each of which would require treatment. In Alaska the principal problem is created by the *Aedes* mosquitoes. Since there is only one brood each year, a single well-timed application will eliminate most of the larvae for an entire season (29, 42, 75, 76).

Two methods of applying insecticides have proved satisfactory in Alaska. They may be applied either to the water for direct control of the larvae or to the soil or snow as a prehatching or pre-flood treatment before the eggs hatch.

Hand sprayers of the Flit-gun type are satisfactory for spraying small puddles. Areas of an acre or more can be treated with a 3- to 4-gallon compressed-air or knapsack sprayer. Larger areas can be sprayed by aircraft (3, 73).

*Application to water.*—Fuel oil No. 2 and diesel oil have been widely used to control mosquito larvae and are still used under some conditions. From 15 to 50 gallons per acre usually gives good results when sprayed on the water. As little as 6 gallons per acre has been effective when 3 to 5 percent of a spreading agent has been added. Three satisfactory spreading agents are sulfonated sperm oil (Nopco 1216), a phthalic glyceryl alkyl resin (Triton B-1956), and an 18-carbon-chain complex amine (Amine 230X) (82).

The pyrethrum larvicides developed in New Jersey have been successfully used in many regions, par-

ticularly in garden pools containing valuable aquatic plants or fish (48). However, the cost is too high to recommend them for use in the extensive mosquito-producing areas of Alaska. Rotenone and creosote have received some publicity from time to time, but it was not until DDT became available that control with insecticides became really feasible. Since then several other insecticides have been developed. The most practical ones from the standpoint of effectiveness and cost are TDE, BHC, lindane, toxaphene, heptachlor, dieldrin, malathion, and parathion. With these, satisfactory control can be obtained with strikingly small dosages, from 0.075 to 0.4 pound per acre, depending on the insecticide (50, 56).

An oil solution is one of the most practical formulations of DDT (103, 104). Concentrations of 1 to 5 percent of DDT in fuel oil No. 2, diesel oil, or kerosene are the most widely used for ground equipment, and 20 to 25 percent prepared with auxiliary solvents for air spraying. A good auxiliary solvent for a 20-percent DDT solution is a methylated naphthalene such as Velsicol NR-70, Solvesso No. 3, or Shell 42. The addition of 0.25 to 0.5 percent of Triton B-1956 increases their effectiveness. Emulsions are also satisfactory, but they are not recommended where fish and wildlife would be affected. Several emulsifiable formulations are available. A typical one contains 25 percent of DDT, 65 percent of xylene or other solvent, and 10 percent of Triton X-100 or other emulsifier. The dosage for the immediate control of larvae in Alaska is 0.05 to 0.1 pound of DDT per acre (103, 104).

TDE, which has a low toxicity to fish, is useful in waters where fish are present. It may be used in the same formulations and applied at the same rates as DDT.

BHC and lindane usually give results about equal to DDT, but oil

solutions are difficult to prepare and these insecticides are not particularly useful in Alaska. The dosage should not be more than 0.05 to 0.1 pound of the gamma isomer per acre, owing to the toxicity of these insecticides to fish.

Toxaphene can be used either in oil solution, as described for DDT, or in emulsion. The dosage should be 0.2 to 0.4 pound per acre. In Alaska toxaphene has not given results equal to DDT, and it is much more toxic to fish. Heptachlor has not been tested in Alaska but was effective in Utah when applied in emulsion at 0.05 pound per acre (60). Dieldrin has been used at about 0.1 pound per acre in oil solution and emulsion. Toxaphene, dieldrin, and heptachlor are two to four times as toxic as DDT to mammals and should be handled accordingly.

Use of most of the organic phosphorus compounds must be supervised carefully, as several of them are toxic to man and animals. They should not be used for routine control unless resistance to DDT and the other common insecticides has been confirmed. Malathion, one of the least toxic of these materials, is being used in California (23, 55, 102) at 0.4 to 0.5 pound per acre. Parathion is likewise being used in California and Utah (102), but special care must be taken in handling this material and it must not be applied over inhabited areas. The dosage is 0.075 to 0.1 pound per acre, or 0.02 p.p.m. in water. Dip-terex<sup>8</sup> (dimethyl 2, 2, 2-trichloro-1-hydroxyethylphosphonate) and parathion have been added directly to water in irrigation ditches in California (45) and Arkansas (46) by means of an automatic applicator (44) before the water flowed over pastures and fields. Control

for distances of about one-half mile has been obtained by this method.

An important recent development in insect control has been the use of granulated insecticides (60, 108, 110, 111, 112). The granules are easily distributed by airplane, ground equipment, or hand. They have enough weight so that they are not so subject to wind drift as sprays or dusts and will penetrate vegetative canopies and thus reach mosquito breeding areas.

*Prehatching treatments.*—Prehatching treatments have been successful in Alaska (105). The insecticides are applied to the dry or moist ground in the late summer or fall or on snow (fig. 19) before the spring thaw (83, 96, 116), and hatching larvae are killed by the residues. The best results have been obtained in areas that are dry in the late summer and early fall and wet only in the early spring.

Prehatching treatments may be made with any of the DDT formulations. One to two pounds per acre will give control for two or more seasons in all but seepage areas, where 2 pounds may be ineffective for even one season. These heavy applications should be made only in areas where there is no danger to wildlife. Much lighter dosages of DDT applied as adulticides have been found to serve as effective prehatching treatments for at least two seasons. In a 100-square-mile plot that had received a total of 0.3 pound of DDT in three treatments in 1949, less than 5 percent of the expected number of larvae were found in 1951 (6).

## PROTECTION AGAINST ADULTS

The control of adult mosquitoes is often more expensive than the control of larvae, as the adults disperse over wider areas. Because of recent developments individuals and communities may now be pro-

<sup>8</sup>The mention of proprietary products does not imply their endorsement by the U.S. Department of Agriculture over similar products not named.





PN-626

FIGURE 19.—Applying DDT dust as a prehatching treatment on snow at Anchorage.

vided with fairly satisfactory protection against adults. The two primary methods used are the personal protective measures and insecticide applications.

### Personal Protection

Where mosquito control is not feasible or when a brood inadvertently emerges in a control area, it may be cheaper and more practical to use such personal protective measures as screens, bed nets, head nets, and repellents.

Screening of all windows and doors with screen wire of 16 meshes to the inch or smaller is a common practice, and in fact a necessity in most communities (8). Bed nets are necessary for campers and people not living in screened houses, as well as for those who work, hunt, or fish outside control areas. Under extreme situations gloves and two thicknesses of clothing provide adequate protection.

When properly applied to the neck, face, and hands, repellents

prevent mosquito bites for several hours, the actual length of time being dependent on the person, the type of repellent used, the species of mosquito, and its abundance (2, 5, 7). Liquid repellents may also be sprayed lightly on garments to prevent mosquitoes from biting through clothing.

The most effective mosquito repellent now available is diethyltoluamide (47, 97). It also provides protection from other common Alaskan pests such as deer flies, black flies, and punkies (*Culisicoides*). When applied to the skin or clothing (fig. 20), it lasts longer than any other material. It is safe to use on the skin and clothing when applied according to instructions. However, it may cause slight irritation if it gets into the eyes. It has desirable cosmetic properties; it dries quickly on the skin to an almost invisible film, is not oily, and is almost odorless. Diethyltoluamide is more resistant to removal by wiping and is more



PN-827

FIGURE 20.—Testing stockings treated with repellents against mosquitoes at Anchorage.

persistent under sweating conditions than other repellents. It is also less easily removed when the skin is rinsed with water.

### Insecticides

Before the newer organic insecticides became available, adult mosquitoes in buildings were destroyed with pyrethrum space sprays. The effectiveness of the newer materials and their low cost make it possible to utilize space sprays both in buildings and over large outdoor areas. In addition, many of these newer insecticides will kill insects when they are applied as residual treatments to surfaces where the insects rest.

*Space treatments.*—Space treatments may be made with sprays or aerosols (16, 59). Droplets with diameters up to 40 microns have been classed as aerosols and those with diameters ranging from this size to 400 microns have been considered to be sprays. In addition to the newer organic materials such as DDT, methoxychlor, and lindane

(62), many sprays may contain pyrethrum, allethrin, or some of the thiocyanates. Malathion is also being used in aerosols, particularly in areas where resistance has developed to the chlorinated hydrocarbons.

Perhaps the most widely known indoor space treatment other than that applied by the hand-pressure sprayer is that produced by the aerosol bomb. A few seconds' application will kill the mosquitoes in an ordinary-sized room or tent. If there is no wind, temporary relief can also be obtained outdoors by releasing the aerosol as one walks in swaths over the area. The directions on the container should be followed.

Mist blowers and large fog machines are used to control adult mosquitoes over large areas. Various smaller mobile units for pneumatic spraying or production of aerosol fog have been found useful (14, 15, 17, 74, 92, 93). Specialized mist-producing equipment built for use around camps in Alaska is shown in figures 21 and 22 (113, 114).

The large aerosol machines may be supplemented by smaller equipment attached to the exhaust manifold of motor vehicles (16, 22, 24, 78, 92, 93). The jeep exhaust aerosol is relatively simple and inexpensive to build and attach to a jeep. Temporary relief from mosquitoes can usually be obtained around campsites and other small localized areas with this equipment. In this unit the oil solution containing the insecticide is introduced into the exhaust system, where it is broken up into aerosol particles. Five percent of DDT in diesel oil is commonly used.

The exhaust aerosol, which was developed by the National Research Council (86), has been modified by Jones and Holten (78) to reduce the back pressure on the engine and increase the atomization of the



PN-828

FIGURE 21.—Weasel trailer equipped with compressor and insecticide tank, releasing aerosol for protection of personnel at Umiat. (Photograph by Charles Wilson.)



PN-829

FIGURE 22.—Small encampment on arctic slope protected by a series of aerosol-producing units consisting of fruit-jar insecticide containers and nozzles attached at intervals to a compressed-air line. (Photograph by Charles Wilson.)

insecticide solution. The modified unit is also easier to clean. The jeep should be operated at a speed of about 5 miles per hour in compound low gear for most efficient aerosol production. The following illustrations and instructions for fabrication and installation of this unit are given with permission of the authors:

Commercial bids for the manufacture of one of the units were about \$30.00, while the cost to construct the unit in our shop was about \$6.00 for labor and \$5.00 for materials, a total of \$11.00. The list of materials required is as follows:

- One 1/8" black pipe tee
- One 1/8" black pipe plug
- One brass 1/4" pipe to 1/4" tubing connection
- One piece 1/4" copper tubing 5" long

One piece 1 1/4" black pipe 2 1/4" long, threaded one end

One 1 1/4" black pipe coupling  
 In addition to these materials for the venturi unit itself, the following are needed for completing the installation on the jeep:

- 4 1/2' of 1/4" i.d. copper tubing for feed line
- Four brass 1/4" pipe to 1/4" tubing connections
- One 1 1/4" black pipe nipple 10" long threaded both ends
- One 1 1/4" black pipe tee
- One brass 1/4" globe valve
- One storage tank

The measurements [fig. 23] of this unit are the same as those given in the National Defense Research Committee report (1945) except for the following:

1. The throat of the venturi was increased from 7/16" i.d. to 1/2" i.d. to eliminate excess back pressure. Measured back pressure was obtained at any engine speed which would allow efficient

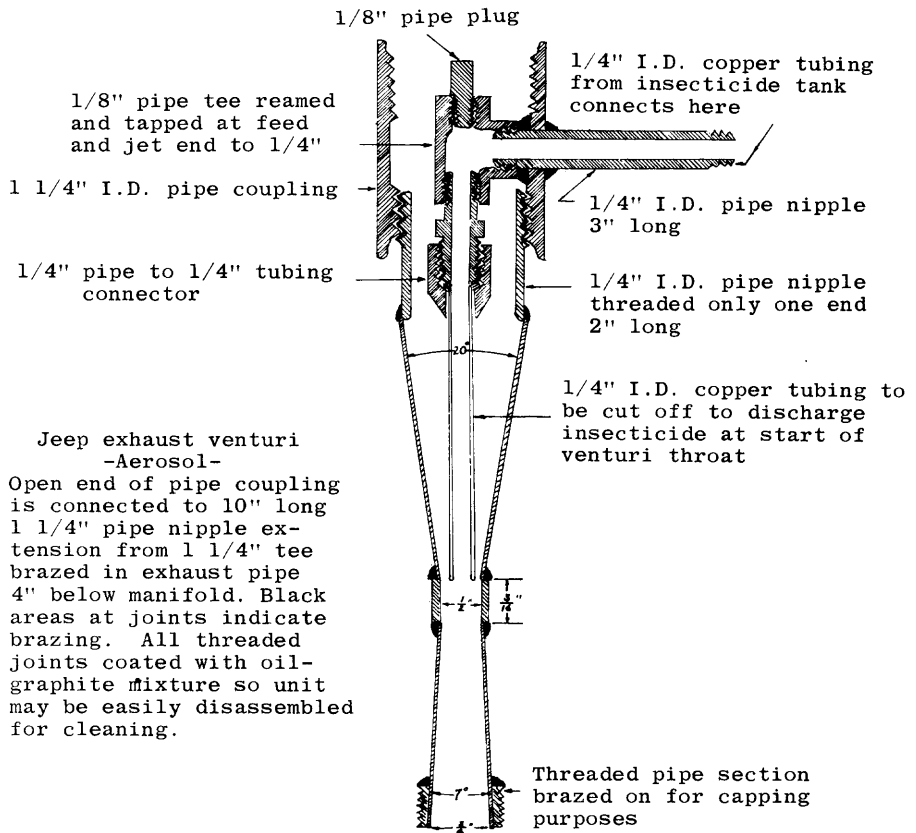
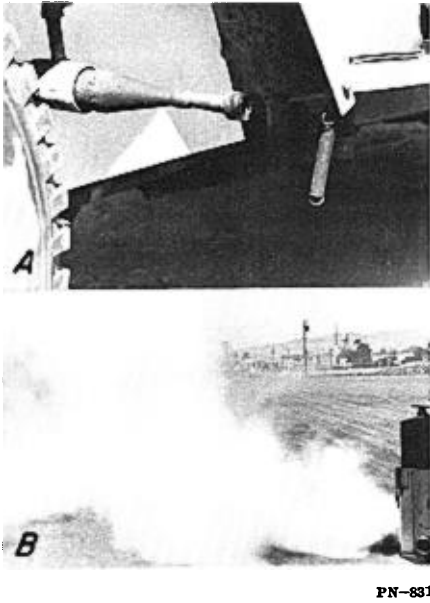

FIGURE 23.—Diagram of a jeep exhaust venturi aerosol. (From Jones and Holten 78.)



PN-831

FIGURE 24.—Jeep exhaust venturi aerosol: A, Closeup view of mounted unit; B, unit in operation.

operation of the exhaust venturi generator.

2. The single-size tube assembly used [fig. 24, A] was substituted for the original curved two-size jet tube so that it could be dismantled and reamed free of carbon with a minimum of tools and time.

3. The fixed mounting in lieu of the flexible mounting permits constant availability and ease of operation. The control valve on the driver's side of the jeep allows one man to both drive and operate the venturi.

The convergent and divergent sections of the venturi can most satisfactorily be formed on a mandrel turned to proper size.

When installing the unit, the exhaust pipe of the vehicle is cut four inches below the manifold and a section of the exhaust pipe long enough to allow the insertion of a tee joint is removed. A 1½" black pipe tee is then brazed into this opening. A 1½" pipe nipple 10" long extends from the tee joint and the venturi unit is screwed onto this extension. Black pipe is used rather than galvanized for ease of brazing parts. An oil and graphite mixture is used to coat all threaded joints so that they may be broken easily even after heating, when the unit must be dismantled for cleaning. The supply tank may be of any size, shape, and capacity, but should be placed so that it is at least 18" to 24"

above the venturi throat. The tank is normally placed in the rear of the jeep above the fender well.

In operation [fig. 24, B], the unit may be controlled to produce a dry fog (aerosol) or a wet fog (mist) by the gravity feed line control valve which controls the volume of insecticide introduced into the venturi. The jeep exhaust pipe is plugged with a 1½" pipe plug when the venturi is in operation. A 1½" i.d. pipe coupling is brazed onto the exhaust pipe to take this plug. When the venturi is not in use, it is capped with a ¾" pipe cap, and the exhaust pipe unplugged.

Although the aerosol treatments can reduce mosquito annoyance in urban or rural communities, the effect of a single treatment seldom lasts more than a few hours. The length of time will depend on the area treated and the abundance and flight habits of the mosquitoes, and best results will always be obtained when the applications are made by experienced operators.

Airplane applications of DDT spray (fig. 25) (14) have proved the most economical method of controlling adult mosquitoes in or near the larger urban centers of Alaska. The formulation most often used contains 20 percent of DDT in fuel oil with at least 20 percent of an auxiliary solvent. The dosage is 0.1 to 0.2 pound of DDT or ½ to 1 pint of spray per acre.

Where mosquitoes have become resistant to DDT, other insecticides are being used, such as lindane, chlordane, aldrin, and dieldrin, which are especially toxic to fish. No insecticide sprays should be used over large bodies of water where they are hazardous to fish. All aircraft spraying should be directed by specialists and trained pilots.

*Residual sprays.*—Many of the organic insecticides, including DDT, will remain effective for several months when applied to the interior surface of buildings and for a week or more when applied to the exterior of buildings or to vegetation. Mosquitoes that



PN-832

FIGURE 25.—Spraying near Fairbanks with one-half pint of 20-percent DDT per acre. Picture taken at midnight.

rest on the treated surfaces will be killed by the residues.

DDT residual sprays for use on buildings should contain 5 percent of DDT either in oil solution or in emulsion. The best results are obtained if all the walls and ceilings are treated. The rate of application should be about 1 gallon per 1,000 square feet. If the surface is not particularly absorptive, reapplication may be necessary. In Alaska an application at the beginning of each mosquito season should be adequate.

Annoyance around buildings can be further reduced by spraying all vegetation to a height of about 10 feet (13). The wider the treated band, the better the results, for the mosquitoes will not be killed until they rest on the sprayed vegetation. During periods of flight activity such treatments may provide poor protection, since infiltrating mosquitoes may cause considerable annoyance before they are killed.

Good control of the *Aedes* species common in Alaska was obtained in

the Cascade Range of Oregon for 10 to 45 days with residual treatments of DDT at 2 to 6 pounds per acre on plots larger than one-half acre. Lindane at 3 pounds per acre gave control equal to that obtained with 4 pounds of DDT (69). In order to avoid damage to vegetation, wettable powders or oil emulsions should be used rather than oil solutions.

**Insecticides are poisonous. When handling or mixing concentrated insecticides, avoid spilling them on the skin and keep them out of the eyes, nose, and mouth. If any is spilled on the skin, wash it off immediately. If any is spilled on the clothing, change it immediately. Try to keep the spray away from the eyes, nose, and mouth when it is being applied. Wash exposed skin surfaces with soap and water and change the clothing after using insecticides. Follow the precautions on the container labels. The extremely poisonous organic**

phosphorus insecticides such as parathion and methyl parathion should be handled only by a person who is thoroughly familiar with their hazards.

### CONTROL OF RESISTANT MOSQUITOES

Resistance to insecticides has developed in many insects in many parts of the world. In some communities in California (54), Florida (25, 79), and Oregon (28), mosquitoes have developed a high

resistance to DDT and other chlorinated hydrocarbon insecticides. Organic phosphorus insecticides have given control in these communities (43, 53). Parathion has been effective in one such area for 8 years, but partial resistance to malathion has developed in a similar area in California (52) after 2½ years. In Alaska resistance is expected to develop very slowly, because only one generation is produced annually by the *Aedes* species, which comprise the major pests.

## Technique for Mosquito Collection and Survey

Specimens that are to be prepared for study in the laboratory or that are to be preserved for a reference collection must receive special attention if they are to serve their purpose.

*Larvae and pupae.*—A white enamel dipper with a smooth stick about 3 feet long inserted in the handle (fig. 26, *A*) is best for collecting larvae and pupae. Remove them from the dipper with an eye dropper or pipette (fig. 26, *C*). As the tip of an ordinary eye dropper is too small for sucking in full-grown mosquito larvae and the pupae, break it off to enlarge the opening.

The larvae and pupae can be reared in the laboratory. Since in general only the mature larvae (fourth instar) can be identified, rear the young larvae to the fourth instar. A careful worker will rear the larvae individually and will save the larval and pupal skins so that they can be associated with the adults.

In the field, preserve the larvae in 70- to 80-percent alcohol. Prevent undue dilution of the alcohol with water; as a precautionary measure change the alcohol after a few hours. Fill the vials (fig. 26,

*B*) with liquid to prevent sloshing and consequent damage to the larvae. Handle the larvae carefully, as the spines and hairs necessary for identification are easily broken off. Specimens retain their shape better if killed in hot water (100°–150° F.) and then transferred to alcohol. A 4-ounce jar or larger (fig. 26, *D*) may be used for carrying live larvae. Injury to larvae will be avoided if the jar is filled to the brim with water.

To make permanent preparations of larvae or larval and pupal skins, remove them from the alcohol in which they have been preserved and mount them on microscope slides. The larval mounts are more satisfactory if the larvae are then punctured with a needle. Place the punctured larvae or skins in Cellosolve for a few minutes and then in a drop of balsam or euparal on a slide, orient them, and cover with a glass coverslip. The abdomen may be cut before the balsam is applied, so that the anal segment and siphon can be turned on the side. Such specimens, if carefully prepared, will last indefinitely.

*Adults.*—The most useful specimens of adult mosquitoes are pre-

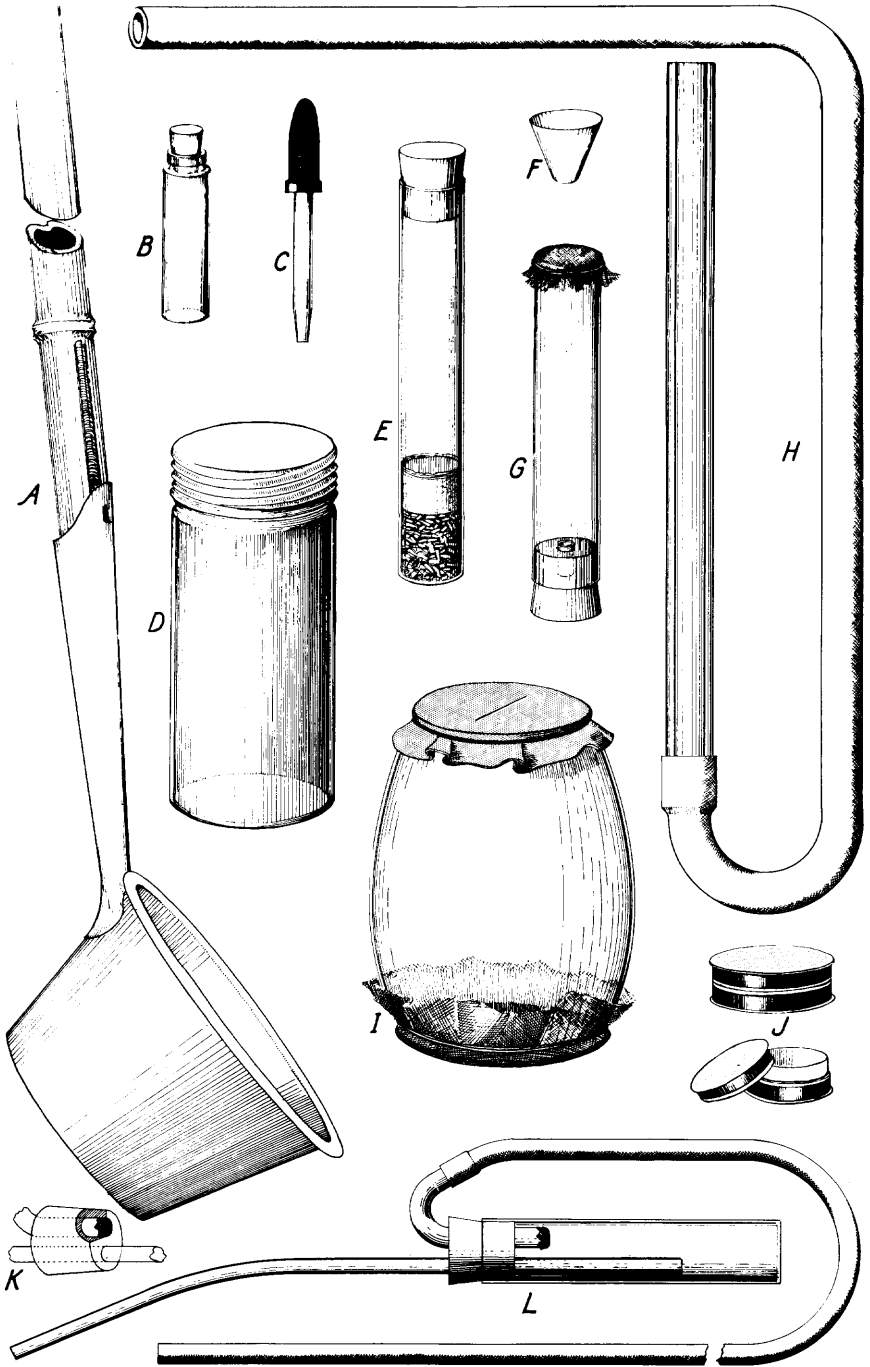

PN-833

FIGURE 26.—Mosquito-collecting equipment: *A*, Dipper; *B*, vial; *C*, wide-mouthed pipette; *D*, jar for carrying live larvae; *E*, killing bottle; *F*, paper funnel; *G*, live tube; *H*, aspirator, straight-tube type; *I*, lantern chimney cage; *J*, pill boxes; *K* and *L*, aspirator, showing construction details.



pared as soon as they are killed or collected. Do not kill those reared in the laboratory for 24 hours after they emerge as adults to allow them time to harden.

The most useful killing bottle (fig. 26, *E*) is a chloroform tube. Fill a strong glass tube to the depth of about one-half inch with cut rubber bands or other small pieces of rubber. Pour in enough chloroform to cover the rubber pieces and close the tube tightly with a cork. When the chloroform has been absorbed by the rubber, tamp in a plug of cotton. On top of the cotton place several disks of blotting paper cut to fit the tube tightly. Such a bottle should last several days before it needs recharging with chloroform, provided it is kept tightly corked when not in use. Place a few strips of soft paper,  $\frac{1}{4}$  to  $\frac{1}{2}$  inch wide, in the tube to prevent the mosquitoes from being unduly rubbed. To increase the number of mosquitoes that can be caught, place a short paper funnel (fig. 26, *F*) in the mouth of the killing bottle. This funnel acts as a barrier to prevent the escape of the specimens before they are killed and to reduce the loss of chloroform fumes.

Another hand-collection device is a suction tube, or aspirator (fig. 26, *L*), made out of a glass or clear plastic tube about three-fourths inch in diameter and 5 to 6 inches long. Intake and outlet tubes inserted through the rubber stopper should be copper, as glass tubes are too easily broken. Fasten bolting cloth or fine mesh copper screening over the inside aperture to the outlet tube. Mosquitoes can then be sucked into the aspirator tube and blown into the killing bottle. Another type of aspirator, as shown in figure 26, *K*, is better for handling adults that are to be transferred to a live jar, or lantern chimney cage (fig. 26, *I*).

After collecting a few specimens in the killing bottle, transfer them to a small container such as a pasteboard pill box. The pill box (fig. 26, *J*) should contain two pieces of soft tissue paper between two layers of cotton. Place the mosquitoes between the layers of tissue. Without the tissue paper the tarsal claws may cling to the strands of cotton and may be broken. Handle the specimens carefully, as scales and hairs that are important for identification are easily rubbed off. In the field, pin the best specimens as they are caught.

Mosquitoes may be kept alive in a large-diameter glass tube or a vial open at both ends (fig. 26, *G*). Cover the top with bobbinet and insert in the bottom a cork, in which a capillary tube is inserted for furnishing water. Place a freshly cut raisin or wad of cotton saturated with sweetened water on top of the bobbinet for food. A glass lantern chimney (fig. 26, *I*) may be similarly equipped as a container for a large number of adults. Generally one end is covered with a sheet of thin rubber. A  $\frac{1}{2}$ -inch slit in the rubber permits the collector to add adults to the container with an aspirator (fig. 26, *H*).

Adults that are to be retained in permanent collections are best mounted on a minuten pin stuck into a small square piece of cork, through which is passed a larger pin. Thrust the tip of the minuten pin through the underside of the thorax of the mosquito, but not far enough to protrude through the mesonotum. The No. 3 entomological pin is generally the best size for holding the cork.

Label the mounted specimens carefully and pin them in a tight insect box. Protect the stored specimens from insect pests and dampness. Place flake naphthalene or paradichlorobenzene in a perforated container and fasten the container securely in one corner of

the insect box to prevent damage from insect intruders. Renew these repellents occasionally.

Many of the northern *Aedes* mosquitoes are difficult to identify, and often only the males can be accu-

rately identified. Mounts of the male genitalia for study purposes may be made as described for mosquito larvae. The genitalia should first be cleared in potassium hydroxide.

## Identification of Species

The principal characters distinguishing the different species are the shape, size, coloration, and scaling of the different body parts. A binocular dissecting microscope with magnifications up to about  $85\times$  is necessary for satisfactory examination. For examining larval parts and slide mounts of male terminalia, a compound microscope with a magnification up to  $400\times$  is necessary. A bright spotlight is required when high magnifications are used.

In the field a good hand lens with a magnification of 10 or  $15\times$  is satisfactory for provisional identi-

fications. After some experience one will be able to identify some of the species with a hand lens or even with the naked eye.

Misidentification of mosquitoes may cause serious confusion. A few specimens that have been correctly identified will be helpful for comparison. If in doubt about the identity of specimens, send them to a specialist with the request that they be named and returned. They may be identified if sent to the Entomology Research Division or to some of the State universities and agricultural experiment stations.

## Keys and Notes for Identification

The 27 species of mosquitoes found in Alaska belong to 4 genera. Keys for their determination are based on characters given in the literature and on others that have been added. The characters used by Vockeroth (109) and by Beckel (11) in keys to females present in Canada have been particularly useful in separating species found in

Alaska. The spines on the anal plate described by Frohne (35) have sometimes been utilized in the larval keys. Only the more important taxonomic data for each species are included here, and only synonyms of recent date are given. The characters used for identifying the *Aedes* species are shown in figures 27 to 32.

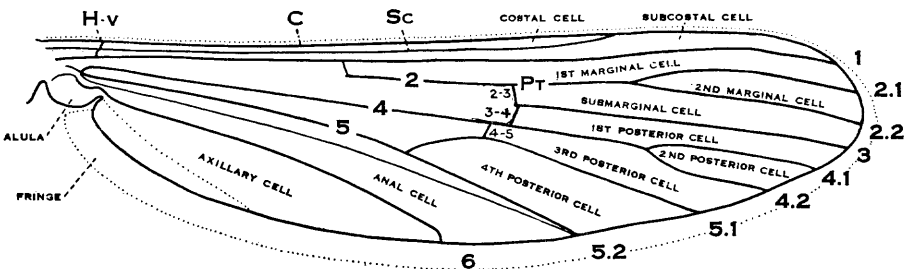

PN-834

FIGURE 27.—Wing of *Aedes* mosquito, illustrating venation (modified from Ross and Roberts 95). *H-v*, humeral cross vein; *C*, costa; *Sc*, subcosta; *Pt*, petiole of vein 2; 1, 2.1, 2.2, 3, 4.1, 4.2, 5.1, 5.2, and 6, longitudinal veins and their branches.

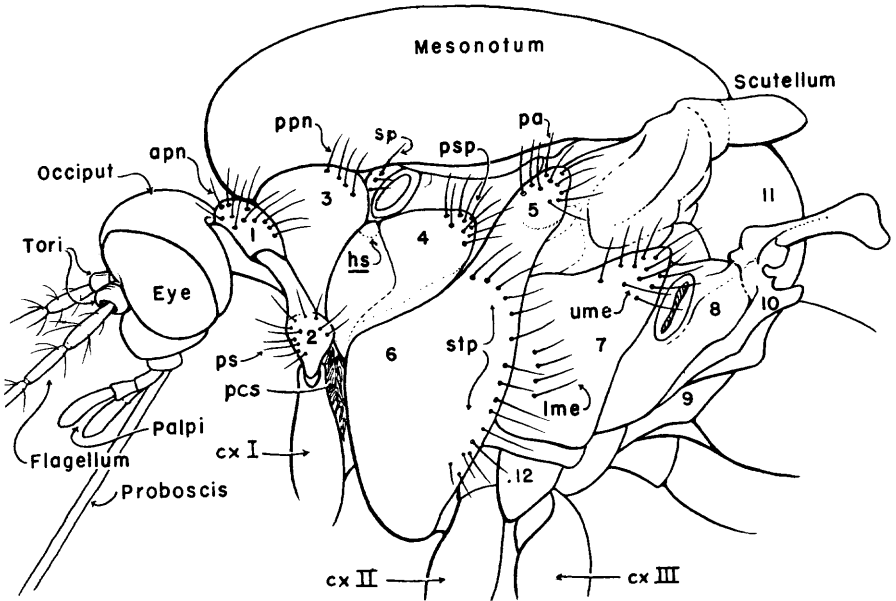

PN-835

FIGURE 28.—Lateral view of mosquito head and thorax. *hs*, hypostigial spot of scales and *pcs*, postcoaxal scale patch. Sclerites of thorax: 1, Anterior pronotum; 2, proepisternum; 3, postpronotum; 4, mesanepisternum; 5, prealar area; 6, sternopleuron; 7, mesepimeron; 8, metanepisternum; 9, metasternum; 10, metepimeron; 11, postnotum; 12, meron. Setae: *apn*, anterior pronotal; *ps*, proepisternal; *ppn*, postpronotal; *sp*, spiracular; *psp*, postspiracular; *pa*, prealar; *stp*, sternopleural; *ume*, upper mesepimeral; *lme*, lower mesepimeral.

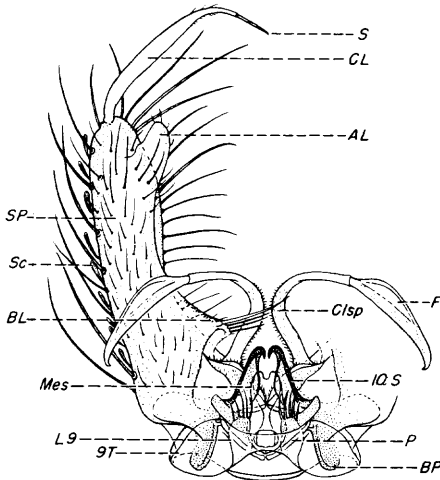

PN-836

FIGURE 29.—Male genitalia of *Aedes*, dorsal view, showing parts: *SP*, sidepiece; *Sc*, scale; *BL*, basal lobe; *Mes*, mesosome; *L9*, lobe of ninth tergite; *9T*, ninth tergite; *S*, spine of clasper; *CL*, clasper; *AL*, apical lobe; *F*, filament of claspette; *Clsp*, claspette; *10S*, tenth sternite; *P*, paramere; *BP*, basal plate.

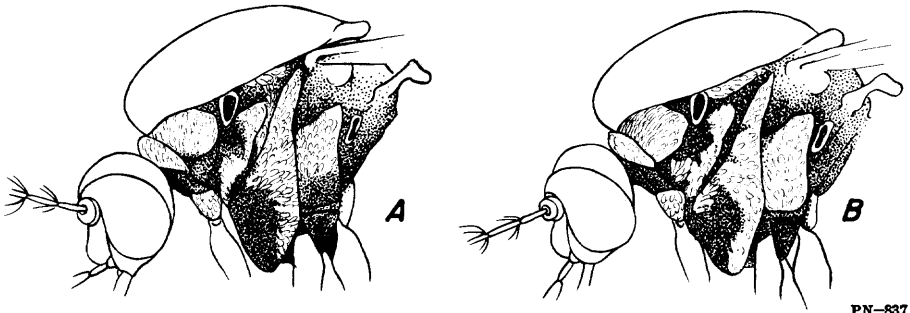

PN-837

FIGURE 30.—A, *Aedes implicatus*, side of thorax showing scaling; B, *Aedes communis*, same.

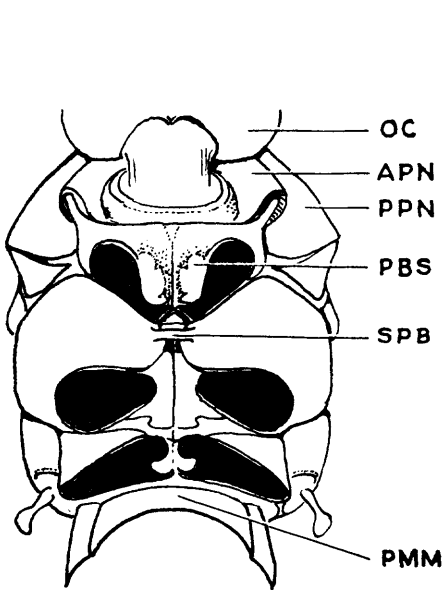

PN-838

FIGURE 31.—Ventral view of thorax of *Aedes*. OC, occiput; APN, anterior pronotum; PPN, posterior pronotum; PBS, probasisternum; SPB, sternopleural bridge; PMM, postmetasternal membrane.

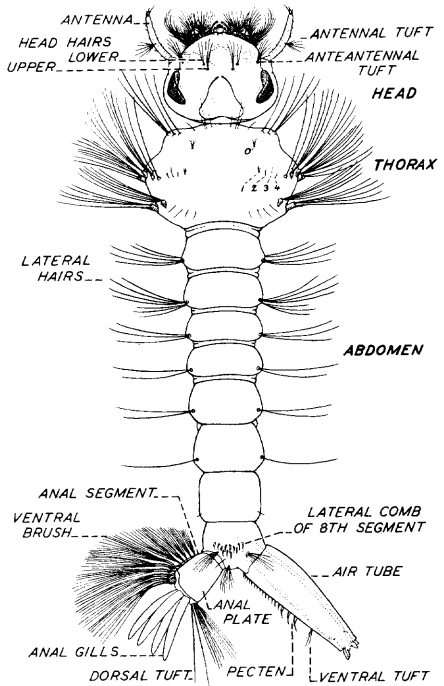

PN-839

FIGURE 32.—Larval characters used in identifying mosquito larvae of Alaska.

KEYS TO GENERA

Adults

- 1. Scutellum trilobed with marginal setae on lobes only; palpi in females much shorter than proboscis..... 2
- Scutellum crescent shaped with marginal setae evenly distributed; palpi of males and females almost as long as proboscis... *Anopheles (earlei*, p. 77)
- 2. Postspiracular bristles present..... *Aedes*
- Postspiracular bristles absent..... 3
- 3. Spiracular bristles present..... *Culiseta*
- Spiracular bristles absent..... *Culex (territans*, p. 79)

*Larvae*

1. Eighth segment without dorsal siphon or respiratory tube... <i>Anopheles (earlei)</i> , p. 77	2
Eighth segment with elongated siphon or respiratory tube.....	2
2. Air tube with siphonal tufts at base.....	<i>Culiseta</i>
Air tube with tufts near or beyond middle.....	3
3. Air tube with two or more pairs of tufts extending to end of tube	<i>Culex (territans)</i> , p. 79
Air tube with only one pair of tufts.....	<i>Aedes</i>

## GENUS AEDES MEIGEN

## KEYS TO SPECIES

*Adults*

1. Tarsal segments ringed with white.....	2
Tarsal segments not ringed with white.....	7
2. Tarsi with white rings at both ends of segments.....	<i>canadensis</i> , p. 48
Tarsi with white rings at base of segments only.....	3
3. Abdomen with dull-yellow scales and irregular dark-scaled areas or completely yellow scaled; tarsal claw as in figure 50, <i>B</i> .....	<i>flavescens</i> , p. 58
Abdomen dark scaled with white or gray dorsal bands.....	4
4. Tarsal claw large, sharply bent, and nearly parallel to long tooth (fig. 46, <i>B</i> ).....	<i>excrucians</i> , p. 55
Tarsal claw smaller, not sharply bent, and not parallel to shorter tooth.....	5
5. Mesepimeral bristles absent; tarsal claw as in figure 66, <i>B</i> .....	<i>riparius</i> , p. 68
Mesepimeral bristles usually present; tarsal claw as in figure 48, <i>B</i> .....	6
6. Lower mesepimeral bristles three or more; torus with or without scales on dorsal half.....	<i>stimulans</i> , p. 69
Lower mesepimeral bristles none to four but rarely more than two; torus with white scales on dorsal half.....	<i>fitchii</i> , p. 56
7. Abdomen without basal white bands or with some narrow or incomplete ones.....	8
Abdomen with basal white bands.....	10
8. Mesonotum reddish brown; fore coxae with central area of brown scales.....	<i>cinereus</i> , p. 50
Mesonotum with narrow median brown stripes; fore coxae with white scales only.....	9
9. Sternopleuron with 5 to 10 setae, of which a vertical line of one to four is just anterior to lower edge of mesepimeron; torus with integument dark brown or black.....	<i>decticus</i> , p. 53
Sternopleuron with 12 to 20 setae, of which a patch of 7 to 12 is anterior to and below lower edge of mesepimeron; torus with integument of outer side yellow to light brown.....	<i>diantaeus</i> , p. 54
10. Postcoxal scales present.....	11
Postcoxal scales absent.....	18
11. Postpronotum with setae scattered over posterior half.....	12
Postpronotum with setae in single or irregular double row along posterior margin.....	13
12. Tarsal claws sharply bent with slender tooth nearly parallel and one-half length of claw (fig. 53, <i>B</i> ).....	<i>impiger</i> , p. 60
Tarsal claw elongate with blunt tooth not parallel with claw (fig. 59, <i>B</i> ).....	<i>nigrripes</i> , p. 64
13. Posterior part of probasisternum with many white scales.....	14
Posterior part of probasisternum without or rarely with few white scales.....	15
14. Mesonotum yellow or rarely gray with dark-brown stripes narrowed at back and extending to scutellum.....	<i>pionips</i> , p. 65
Mesonotum brown or occasionally with faint dark markings	<i>hezodontus</i> ("tundra" variety), p. 59
15. Sternopleuron with scales extending to frontal border.....	16
Sternopleuron with scales not extending to frontal border.....	17

16. Mesonotum yellowish to light golden brown with dark-brown lines..... *punctor*, p. 67; *aboriginis*, p. 47  
 Mesonotum brown or occasionally with faint dark markings..... *punctor* ("tundra" variety), p. 67
17. Wings with scattered line of white scales extending from base of costa to humeral cross vein..... *cataphylla*, p. 49  
 Wings dark scaled or with patch of white scales at base of costa..... *implicatus*,<sup>9</sup> p. 61
18. Sternopleuron with scales extending to frontal border..... *communis*, p. 51  
 Sternopleuron with scales not extending to frontal border..... 19
19. Mesonotum yellowish brown with median brown stripes; wings with pale scales extending from base of costa to humeral vein..... *pullatus*, p. 66  
 Mesonotum bronzy brown with gray scales around margins and rarely with darker markings centrally; wings dark scaled or with small patch of pale scales at base of costa..... *intrudens*, p. 62

### Larvae

1. Pecten of air tube with one or more of distal teeth more widely spaced..... 2  
 Pecten teeth of air tube equally spaced..... 10
2. Anal segment ringed by plate..... *nigripes*, p. 64  
 Anal segment not ringed by plate..... 3
3. Hair tuft of air tube distinctly basal of last pecten tooth..... *cataphylla*, p. 49  
 Hair tuft of air tube even with or distad of last pecten tooth..... 4
4. Antennae longer than head..... *diantaeus*, p. 54  
 Antennae shorter than head..... 5
5. Apical setae of lateral valves (i.e., triangular flaps at apex of tube) hook shaped, as long as longest pecten tooth..... *excrucians*, p. 55  
 Apical setae of air-tube valves barely discernible, not longer than shortest pecten tooth..... 6
6. Upper and lower head hairs single or double..... 7  
 Upper head hairs three or more branched, lower two or more branched..... 8
7. Antennae not longer than anal segment..... *riparius*, p. 68  
 Antennae at least one-fourth longer than anal segment..... *decticus*, p. 53
8. Upper head hairs two or three, lower double..... *flavescens* (in part), p. 58  
 Upper head hairs usually four or more, lower two or three..... 9
9. Tuft of air tube with five to seven hairs..... *intrudens*, p. 62  
 Tuft of air tube with two or three hairs..... *cinereus*, p. 50
10. Anal segment ringed by plate or very narrowly open ventrally..... 11  
 Anal segment not ringed by plate, broad opening ventrally..... 12
11. Comb of eighth segment a row of 5 to 9 or rarely 10 scales; anal plate closed..... *hexodontus*, p. 59  
 Comb of 10 to 19 scales; anal segment narrowly open or closed..... *punctor*, p. 67
12. Both pairs of head hairs single or occasionally with one or two hairs double..... 13  
 Both pairs of head hairs not single and at least one pair multiple..... 15
13. Comb on eighth segment of 40 or more scales..... *communis*, p. 51  
 Comb on eighth segment of less than 30 scales..... 14
14. Comb on eighth segment of 8 to 16 thornlike scales, lateral spinules less than half as long as apical spine..... *impiger*, p. 60  
 Comb of 15 to 25 blunt scales, lateral spinules nearly as long as apical spine..... *implicatus*, p. 61
15. Apical setae of air-tube valves hook shaped and as long as lateral valve..... *fitchii*, p. 56  
 Apical setae of air-tube valves inconspicuous, not so long as lateral valve..... 16
16. Air tube with pecten teeth on basal one-third or occasionally slightly farther; anal gills usually twice length of anal segment; (spines on apex of anal plate long and slender, fig. 63)..... *pullatus*, p. 66  
 Air tube with pecten extending nearly one-half length of tube; anal gills seldom twice length of anal segment..... 17
17. Comb on eighth segment with 60 or more scales; air tube about  $2\frac{1}{2} \times 1$  (spines on apex of anal plate short and slender, fig. 61)..... *pionips*, p. 65  
 Comb on eighth segment with less than 40 scales; air tube about  $3 \times 1$ ..... 18

<sup>9</sup> About 10 percent of the females of this species have a few scales extending to the frontal border of the sternopleuron.

18. Comb scales thornlike; apical spine more than twice as long as any lateral spinule..... *flavescens* (in part), p. 58  
 Comb scales acute apically but not thornlike; apical spine less than twice as long as lateral spinules..... 19
19. Upper head hairs six to seven, lower four to five..... *canadensis*, p. 48  
 Upper head hairs three to four, lower two to four..... 20
20. Anal segment longer than wide; mesothoracic hair No. 1 double or triple..... *stimulans*, p. 69  
 Anal segment about as long as wide; mesothoracic hair No. 1 single..... *aboriginis*, p. 47

### Male Genitalia

1. Clasper inserted before apex of sidepiece; unequally bifurcate at base..... *cinereus*, p. 50  
 Clasper not inserted before apex of sidepiece; not branched at base..... 2
2. Basal lobe without spines..... 3  
 Basal lobe with spines..... 5
3. Filament of claspette narrow and of approximately equal width..... *canadensis*, p. 48  
 Filament of claspette expanded along one margin..... 4
4. Filament of claspette with one side roundly expanded at base..... *nigripes*, p. 64  
 Filament of claspette with one side expanded to sharp point at base..... *excrucians*, p. 55
5. Basal lobe with one spine..... 6  
 Basal lobe with two or more spines..... 14
6. Apical lobe with short appressed setae..... *aboriginis*, p. 47; *hexodontus*, p. 59; *punctor*, p. 67  
 Apical lobe with long hairs or nearly bare..... 7
7. Basal lobe extending almost to apical lobe..... *flavescens*, p. 58  
 Basal lobe a small area at base of sidepiece..... 8
8. Apical lobe of sidepiece nearly bare..... 9  
 Apical lobe distinctly setose..... 10
9. Filament of claspette expanded into sharp projection near base..... *implicatus*, p. 61  
 Filament of claspette expanded in gradual curve near base..... *cataphylla*, p. 49
10. Filament of claspette sickle shaped with small notch at base..... *fitchii*, p. 56  
 Filament of claspette not notched at base..... 11
11. Basal lobe rounded..... 12  
 Basal lobe cone shaped or wedge shaped..... 13
12. Filament of claspette expanded to its maximum width at base..... *communis*,<sup>10</sup> p. 51; *pionips*, p. 65  
 Filament of claspette expanded to its maximum width near middle..... *stimulans*, p. 69
13. Basal lobe projecting in cone shape at right angles to sidepiece..... *riparius*, p. 68  
 Basal lobe evenly sloped to its maximum width at basal edge..... *impiger*, p. 60
14. Apical lobe with dense tuft of long hairs..... 15  
 Apical lobe without tuft of hairs..... 16
15. Apical lobe conical, well developed; claspette stem with sharp angle near apex..... *diantaeus*, p. 54  
 Apical lobe flattened, oval; claspette stem with rounded shoulder near apex..... *decticus*, p. 53
16. Claspette with sharp angular projection ending in stout setae at middle..... *intrudens*, p. 62  
 Claspette with rounded angle at middle..... *pullatus*, p. 66

<sup>10</sup> Postcoxal scale patch present on male *pionips* and absent on *communis*.

### *Aedes aboriginis* Dyar

*Aedes aboriginis* Dyar, Insector Inscitiae Menstruus 5: 99. 1917.

*Female*.—Mesonotum yellowish to light golden brown with paired dark-brown stripes and posterior half lines. Postpronotum with setae in single or irregular double

row along posterior margin. Postcoxal scales present. Sterno-pleuron with scales extending to frontal border. Scutellum with yellow or bronzy bristles. Probasisternum without white scales on posterior part. Lower mesepimeral bristles one or two. Abdomen black

with basal white bands widening at sides. Wings dark scaled in about 95 percent of specimens. Legs black.

*Male genitalia* (fig. 33).—Side-pieces three times as long as broad; apical lobe long and rounded with short curved setae; basal lobe flatly conical with numerous setae and long curving spine near base. Claspette pilose, slightly curved, and expanded near middle; filament shorter than stem, slightly expanded at middle, and terminating in blunt curved point.

*Larva*.—Antennae sparsely spined. Head hairs, upper usually three to four and lower two to four. Mesothoracic hair No. 1 single. Lateral abdominal hairs one to two long hairs. Comb on eighth segment with about 30 scales in patch. Air tube about  $3 \times 1$ ; pecten fine and even and not reaching middle, followed by four to six large hairs; apical setae not so long as lateral valve. Anal segment about as long

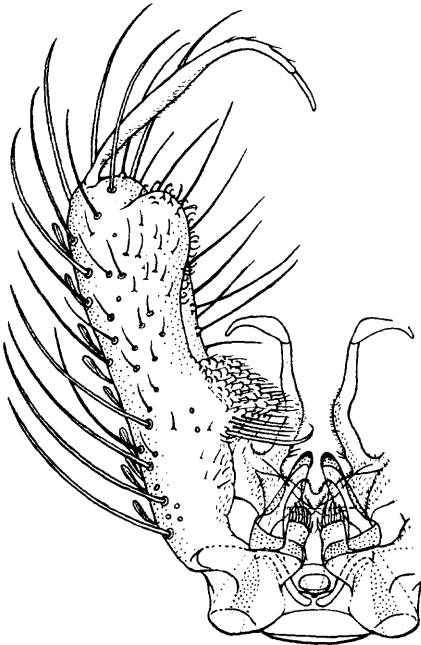

PN-840

FIGURE 33.—*Aedes aboriginis* male genitalia.

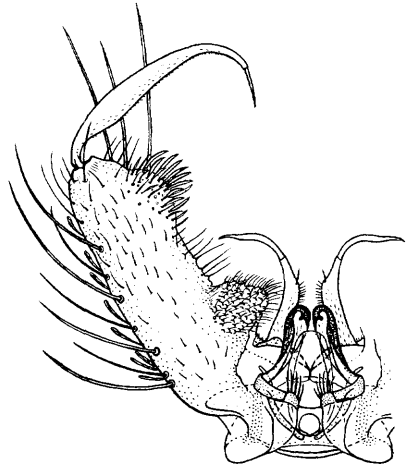

PN-841

FIGURE 34.—*Aedes canadensis* male genitalia.

as wide, anal plate extending to near ventral line; anal gills pointed and longer than segment.

*Bionomics*.—This species has been recorded from several localities in the Panhandle (map 9). Larvae were collected in May, June, and July in roadside borrow pits that were devoid of vegetation (Frohne and Sleeper 42). Nothing further is known of the species' habits or behavior in Alaska.

### *Aedes canadensis* (Theobald)

*Culex canadensis* Theobald, Monog. of Culicidae of World, v. 2, p. 3. 1901.

*Female*.—Mesonotum reddish brown with pale-yellow scales around margins. Abdomen black without basal white bands or with narrow indistinct ones; sides with triangular white spots. Wing scales all dark. Legs black; hind and midtarsal segments apically and basally white banded; fore tarsus banded on first and second segments; last segment of hind leg entirely white scaled.

*Male genitalia* (fig. 34).—Side-pieces slightly more than twice as long as wide; apical lobe large, low, and broadly rounded with short bladellike setae; basal lobe long,



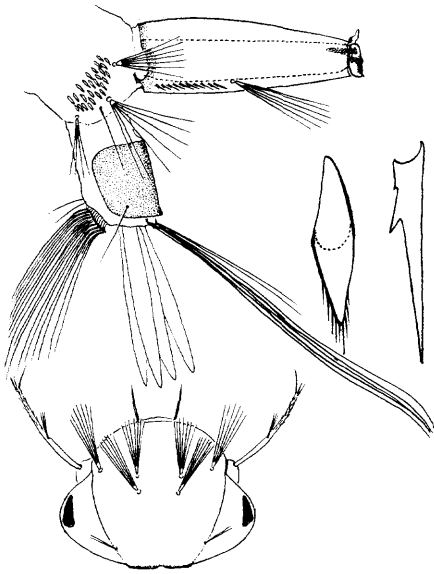

FN-842

FIGURE 35.—*Aedes canadensis* larva.

with many short setae. Claspette cylindrical and setose, larger seta before apex; filament narrow, linear, pointed, and slightly shorter than stem.

*Larva* (fig. 35).—Antennae spinose. Upper head hairs six to seven, lower four to five. Lateral abdomen hairs usually double on first to fifth segments and single on sixth. Comb on eighth segment with 25 to 40 scales in irregular patch. Air tube  $3 \times 1$ ; pecten even, reaching beyond one-third of tube, followed closely by tuft of four to six medium hairs; apical setae shorter than lateral valve. Anal segment longer than wide, not ringed by plate; anal gills pointed and about as long as segment.

*Bionomics*.—Craig and Pienkowski (21) found *canadensis* near Circle, and also they reported it to be the dominant pest mosquito in late July of 1955 at a locality near Eielson Air Force Base. These are the only records for the species from Alaska (map 9). They are of special interest since the area between Eielson and Fairbanks was

surveyed by the Alaska Insect Control Project in 1947 and studied intensively during the entire spring and summer of 1948. It is hardly conceivable that such an easily recognized species could have been missed; more likely this is further evidence of the year-to-year instability of the mosquito population in central Alaska. No larvae have been collected in Alaska. In the United States and Canada larvae develop in temporary or semipermanent, shaded, woodland pools containing fallen leaves.

### *Aedes cataphylla* Dyar

*Aedes cataphylla* Dyar, Insector Mensurae 4 : 86. 1916.

*Female*.—Mesonotum gray around sides with golden-brown scales in middle, which sometimes show faint dark lines. Postpronotum with setae in single or irregular double row along posterior margin. Postcoxal scales present. Sternopleuron with scales not extending to frontal border. Probasissternum without white scales on posterior part. Lower mesepimeral bristles two to seven. Hypostigial spot of scales usually present. Abdomen black with basal segmental white bands. Wing scales dark with scattered pale scales extending from base of costa to humeral cross vein. Legs black with mixture of pale scales; tarsi mostly black.

*Male genitalia* (fig. 36).—Sidepieces about three times as long as wide; apical lobe small, elongated, and narrowly attached with few short spines; basal lobe small, elevated into transverse ridge at base with row of long setae and slender spine at margin. Claspette lightly hirsute except at apex; filament expanded in gradual curve near middle.

*Larva* (fig. 37).—Both pairs of head hairs single. Comb on eighth segment in two irregular rows. Air tube about  $3 \times 1$ ; evenly spaced



FIGURE 36.—*Aedes cataphylla* male genitalia.

pecten teeth to hair tuft and three to five widely spaced teeth beyond. Anal segment with plate extending well down sides; anal gills as long or longer than segment.

*Bionomics.*—This is a less common species found in central Alaska from Anchorage north to Fairbanks and west to Teller (map 7). Larvae occur in shallow temporary or semipermanent pools in *Carex* or *Calamagrostis* marshes. During 1948 larvae were collected at nine localities during the last week of May and at one locality near Anchorage on September 15.

***Aedes cinereus* Meigen**

*Aedes cinereus* Meigen, System. Besch. Eur. Zweifl. Ins., v. 1, p. 13. 1818.

*Female.*—Mesonotum clothed with reddish-brown scales. Post-coxal scale patch present. Probasi-sternum bare. Lower mesepimeral bristles absent. Abdomen black without white bands or with narrow partial or complete ones; lateral spots usually joined to form line. Wing scales dark. Legs dark brown; coxa of front leg with white

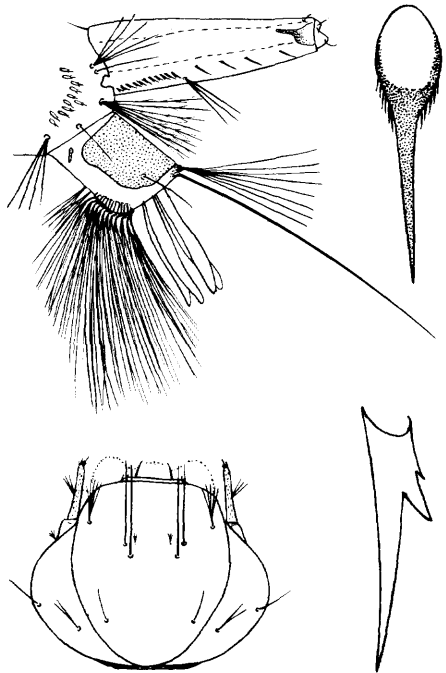

FIGURE 37.—*Aedes cataphylla* larva.

scales and central patch of brown scales on anterior surface.

*Male genitalia* (fig. 38).—Sidepieces twice as long as wide, broad, and sharply tapered to densely spined apex. Clasper subapically inserted, with forked arms of unequal length. Claspette two

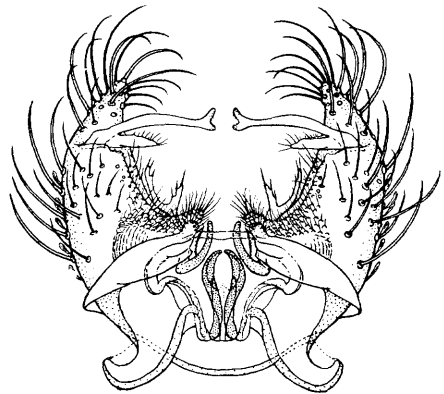

FIGURE 38.—*Aedes cinereus* male genitalia.

branched with three spines at apex of each branch.

*Larva* (fig. 39).—Antennae shorter than head. Upper head hairs three to seven, lower two to five, tufts set close together. Lateral abdominal hairs double on first and second segment, single and long on third to sixth. Comb on eighth segment with 10 to 12 slender pointed scales. Air tube about  $3 \times 1$ ; pecten extending past middle of tube, last three or four teeth detached, tuft with two or three hairs; apical setae very short. Anal segment longer than wide, not ringed by plate; gills very long and lanceolate.

*Bionomics*.—This species has been taken in largest numbers near Fairbanks, but larvae have also

been collected at Anchorage and Valdez. The species has also been taken in the tundra zone at Nome and Kotzebue (map 4). Partially shaded, shallow, semipermanent pools in *Carex* and *Calamagrostis* marshes are favored habitats for the larvae. At Fairbanks in 1948 fourth-stage larvae were collected from May 26 through July 15 and were most numerous about June 3. No fourth-stage larvae were taken at Anchorage until June 20, but they persisted until October 8 and were most numerous on September 15. The species is easily recognized in the adult stage and has not been observed to be a serious pest in Alaska.

### *Aedes communis* (DeGeer)

*Culex communis* DeGeer, Mem. Servir Hist. Insectes, v. 6, p. 316, figs. 2 and 5. 1776.

*Aedes protivus* Dyar, Insector Inscitiae Menstruus 10: 2. 1922.

*Female*.—Mesonotum dull yellow or gray scaled with narrow pale median line separating paired dark-brown lines and with posterior brown half lines. Coloration variable and may be brown scaled centrally with mixture of pale scales and border of grayish-yellow scales. Postpronotum with setae in single or irregular double row. Postcoxal scale patch absent. Sternopleuron with scales extending to frontal border (fig. 30, B, p. 44). Probasi-sternum with posterior part bare. Lower mesepimeral bristles two to five. Abdomen dark brown with basal white bands. Wings dark scaled with patch of two or three to many pale scales at base of costa. Legs dark with femora partially pale.

*Male genitalia* (fig. 40).—Side-pieces about three times as long as wide; apical lobe large, rounded, with many long spinelike setae; basal lobe small, quadrilateral in outline, partially detached at base, surface with some small setae,

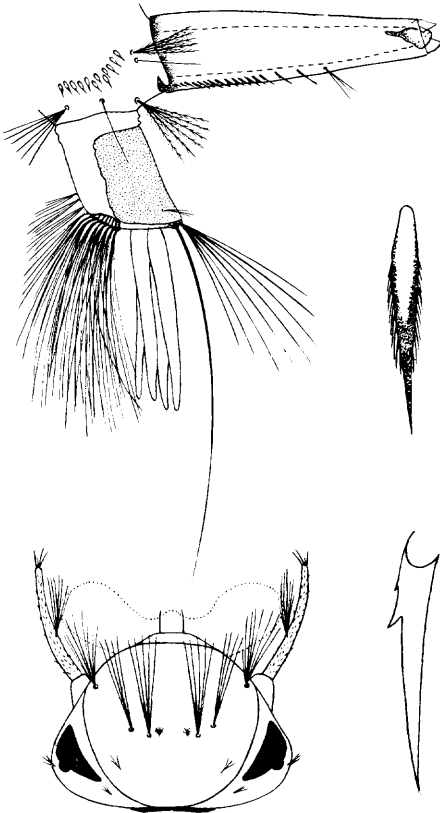

PN-846

FIGURE 39.—*Aedes cinereus* larva.



PN-847

FIGURE 40.—*Aedes communis* male genitalia.

several larger curved ones and stout spine on margin. Claspette lightly hirsute on basal half, apical half more slender; filament angularly expanded to its maximum width near base.

*Larva* (fig. 41).—Both pairs of head hairs single. Lateral abdominal hairs double on first to fifth segment and single on sixth. Comb on eighth segment with 50 to 60 scales in triangular patch. Air tube stout and about  $2\frac{1}{2} \times 1$ ; pecten evenly spaced to near middle of tube, tuft of four to six hairs. Anal segment longer than wide, plate extending only about two-thirds distance down sides, anal gills one to three times length of anal segment.

*Bionomics*.—This species is one of the most common and widely distributed species in Alaska (map 1). Although it is predominantly a forest species, it has been taken at

Umiat, Kotzebue, and Teller. Larvae have been found in a wide variety of pools and appear to be able to live in practically all shallow pools that are temporary but last long enough for adult emergence. Larval population density is often as high as 500 per dip in *Sphagnum*-heath bog pools. At Anchorage in 1948 peak adult emergence occurred about May 26 and in reduced numbers continued until the last of June. Some fourth-stage larvae were found as late as September 15. At Fairbanks peak adult emergence was reached about June 6, and no larvae were found after June 15.

The frequency of collection and high population density of pools producing *communis* may exaggerate the real importance of this spe-

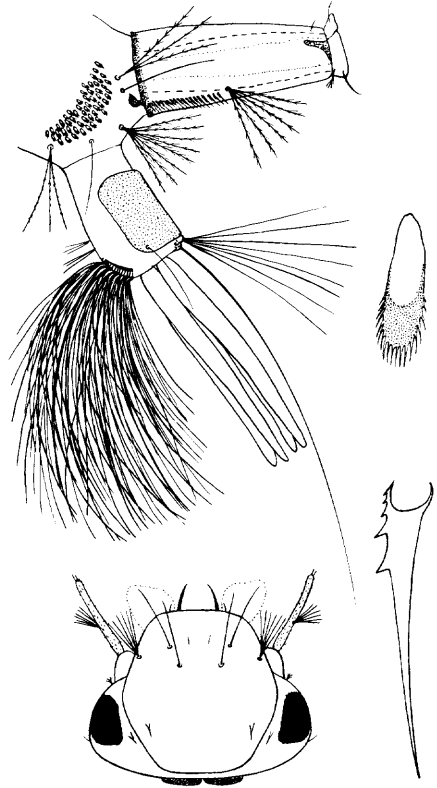

PN-848

FIGURE 41.—*Aedes communis* larva.

cies. The high population density tempts the collector to sample such pools and pay relatively less attention to the vastly more numerous pools where larvae are often hard to find and where species other than *communis* predominate. This fact combined with some evidence that *communis* may not attack man to any great extent (Hocking 65) raises a serious doubt as to the actual pest importance of the species in Alaska.

***Aedes decticus* Howard, Dyar,  
and Knab**

*Aedes decticus* Howard, Dyar, and Knab, Mosquitoes of No. and Cent. Amer., v. 4, p. 737. 1917.

*Aedes pseudodiantaeus* Smith, Brooklyn Ent. Soc. Bul. 47:19. 1952.

*Female*.—Torus with integument dark brown or black. Occiput with white and pale-yellow scales, subdorsal patches of dark brown, and scattered erect dark scales. Mesonotum with median brown stripes separated by line of pale-yellow scales; posterior half stripes usually distinct. Postcoxal scale patch absent. Sternopleuron with 5 to 10 setae, of which a vertical line of 1 to 4 is just anterior to lower edge of mesepimeron. Lower mesepimeral bristles absent. Abdomen without basal white bands or occasionally with narrow bands on some segments. Wing scales dark. Legs black with femora partially pale scaled.

*Male genitalia* (fig. 42).—Sidepieces more than twice as long as wide; apical lobe a flattened elongated oval extending almost to basal lobe, ventral side with large dense tuft of fine setae; basal lobe with long spine at its base and two curved spines on its apical projection. Claspette stout basally and narrowed beyond curved shoulder near apex, shoulder bearing small setae; filament of claspette slender at base, greatly expanded and ending in two small points.

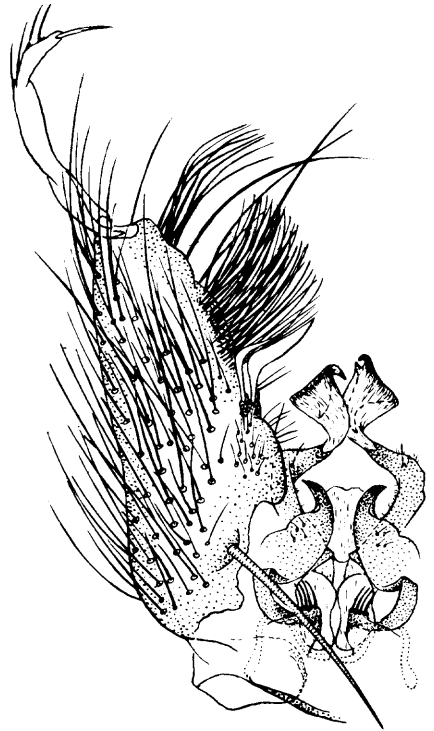

PN-849

FIGURE 42.—*Aedes decticus* male genitalia.

*Larva* (fig. 43).—Antennae almost as long as head with one long and two short setae at apex, antennae tuft just before middle. Upper and lower head hairs single or double. Comb on eighth segment of five to seven scales, each scale with long median spine and fringe of basal lateral spinules. Air tube 3 or 4 × 1; pecten extending to about middle with one to three detached teeth, hair tuft even with last pecten tooth. Anal segment longer than wide and nearly ringed by plate.

*Bionomics*.—This is a forest species recorded from larvae collected in black spruce bog pools near Fairbanks and from quaking bog pools in the Copper River Valley near Chitina (map 9). Larvae taken at the latter locality were reported by Frohne and Frohne (40) to be associated with *Culiseta morsitans*,

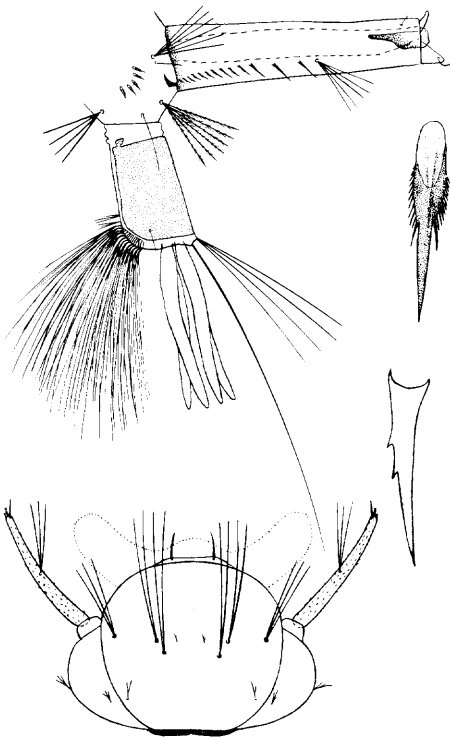

PN-850

FIGURE 43.—*Aedes decticus* larva.

*Culex territans*, and several species of *Aedes*. At Fairbanks fourth-stage larvae were taken on May 29. Adults believed to be *decticus* were collected at Fort Yukon on July 5.

### *Aedes diantaeus* Howard, Dyar, and Knab

*Aedes diantaeus* Howard, Dyar, and Knab, Mosquitoes of No. and Cent. Amer., v. 4, p. 758. 1917.

*Female*.—Torus with integument of outer side yellow to light brown. Occiput with pale-yellow scales. Mesonotum with narrow median brown stripes separated by faint line of yellow scales; posterior half lines indistinct; sides pale yellowish. Postcoxal scale patch absent. Sternopleuron with 12 to 20 setae, of which a patch of 7 to 12 is just

anterior to and below lower edge of mesepimeron. Lower mesepimeral bristles absent. Abdomen without basal white bands or occasionally with narrow bands on some of segments. Wing scales dark. Legs black with femora partially pale scaled.

*Male genitalia* (fig. 44).—Side-pieces more than twice as long as wide; apical lobe conical, well developed, projecting mesally, ventral side at base with dense group of fine long setae; basal lobe with long stout spine at its base and two broad stout spines on its apical projection. Claspette broad basally and constricted beyond middle to form sharp angular projection bearing several small setae; filament greatly expanded and ending in recurved point.

*Larva* (fig. 45).—Antenna longer than head with three setae of equal length at apex, antennal tuft with few hairs near middle. Upper head hairs two to five; lower two to three. Comb on eighth segment

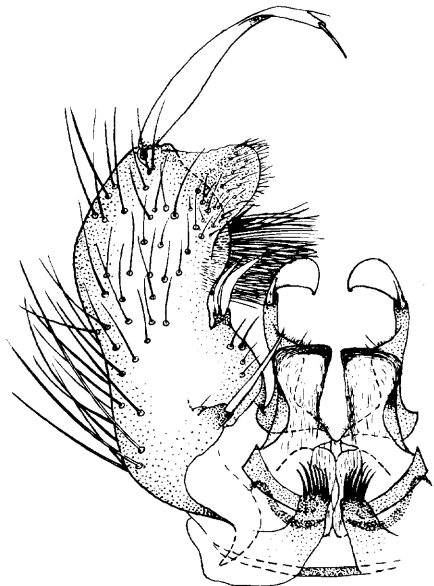

PN-851

FIGURE 44.—*Aedes diantaeus* male genitalia.

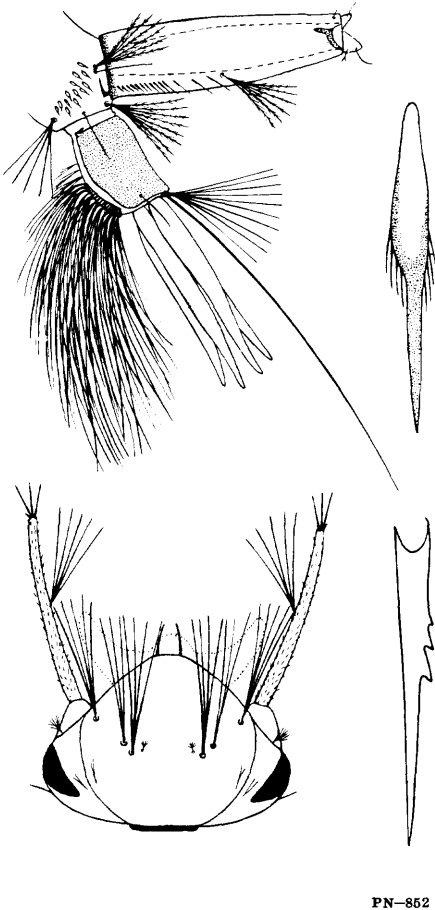

FIGURE 45.—*Aedes diantacus* larva.

with about 6 to 13 scales, each scale a long median spine without lateral fringe of spinules. Air tube about  $1 \times 3$ ; pecten extending to about middle with one to three detached teeth followed by tuft of long hairs. Anal segment longer than wide, nearly ringed by plate.

*Bionomics*.—This is a forest species, of which small numbers of larvae have been collected near Anchorage, Big Timber, Chitina, and Fairbanks (map 4). Larvae tend to be associated with *Aedes punctor* in semipermanent pools or along the shallow marshy margins of permanent pools and ponds. Fourth-stage larvae have been taken at Fairbanks from May 26 until

June 10 and at Anchorage from May 10 until October 8.

### *Aedes excrucians* (Walker)

*Culex excrucians* Walker, Insecta Saundersiana. Diptera, v. 1, p. 429. 1856.

*Aedes alopnotum* Dyar, Insector Insectilae Menstruus 5: 98. 1917.

*Female*.—Torus with inner surface predominantly white scaled. Mesonotum yellowish white with median brown stripe, varied pattern of brown and white scales or completely reddish-brown scaled. Mesepimeral bristles absent or rarely there may be one. Abdomen black with basal segmental white bands and frequently with scattered white scales. Wings predominantly dark scaled with pale scales intermixed. Legs black with tarsal white bands broad on hind legs and usually absent on last segment of midtarsus and last two segments of fore tarsus; tarsal claw large with tooth long and parallel (fig. 46, B).

*Male genitalia* (fig. 46, A).—Sidepieces about three times as long as wide; apical lobe prominent with small setae; basal lobe slightly raised, rugose, and extending to base of apical lobe, surface covered with short setae. Claspette hirsute except at apex; filament angularly expanded to sharp point near base.

*Larva* (fig. 47).—Antennae shorter than head. Upper head hairs triple, lower usually double. Lateral abdominal hairs usually double on first and second or third segment and single on rest. Comb on eighth segment of about 20 to 25 scales in triangular patch. Air tube slender, about  $4 \times 1$ ; pecten not reaching middle with last two or three teeth detached, tuft even with last pecten tooth; lateral valve with hook-shaped setae at apex. Anal segment longer than wide, plate extending well down side; anal gills slightly longer than segment.

PN-852

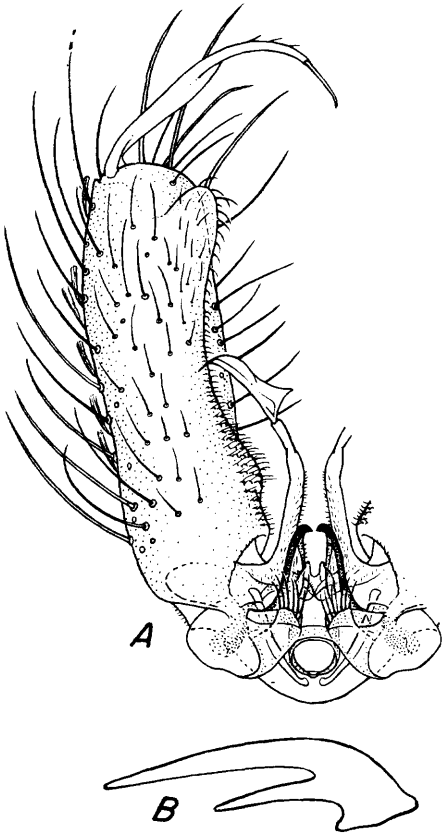

PN-853

FIGURE 46.—*Aedes excrucians*: A, Male genitalia; B, claw of female.

*Bionomics*.—This species is widely distributed through low forested areas from Wrangell north to Fort Yukon and west to Naknek. In the northwest it has been collected at Kotzebue and Noatak (map 5). Larvae are prevalent in semipermanent pools containing an emergent cover of *Carex rostrata* and *Equisetum fluviatile* or in tidal flats containing *Triglochin*. A water depth of 8 to 12 inches is favored. Peak adult emergence occurs at Anchorage near the first of June and about 2 weeks later at Fairbanks. The species is thus near the end of the *Aedes* species succession series. Of the five band-legged species, it appears to be the most nu-

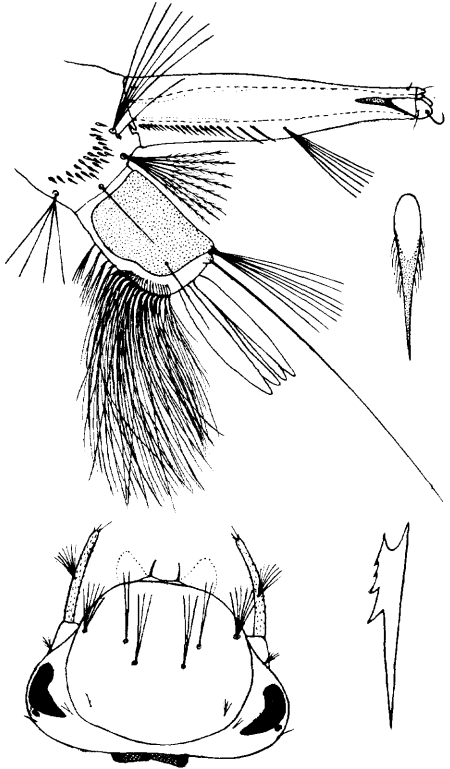

PN-854

FIGURE 47.—*Aedes excrucians* larva.

most numerous near rivers in areas where there are extensive marshlands.

### *Aedes fitchii* (Felt and Young)

*Culex fitchii* Felt and Young, Science (n.s.) 20: 312. 1904.

*Female*.—Torus with white scales on dorsal half. Mesonotum yellowish white to light brown with broad median brown stripe or variable pattern of brown and light scales. Lower mesepimeral bristles none to

merous and troublesome. The habit of biting during warm sunny afternoons when few other mosquitoes are active increases the pest importance of this species. Populations are more localized than those of the dark-legged species, at least during years when mosquitoes are exceptionally numerous. They are



two, rarely three or four. Abdomen black with basal white bands, sometimes with apical white scales that may extend into median white line. Wings dark scaled, usually with admixture of white scales along costa. Legs black; tarsi with basal white bands on all except last two segments of fore tarsi and first segment of midtarsus, white bands broader on hind legs; tarsal claw with short tooth not parallel with claw (fig. 48, B).

*Male genitalia* (fig. 48, A).—Sidepieces about three times as long as wide; apical lobe prominent and slightly elongated, surface clothed with long setae bordered by number of short ones; basal lobe triangular, densely tubercular with many setae, those at margin of base longer and preceded by spine. Claspette lightly hirsute except at apex; filament short and sickle shaped with notch at base.

*Larva* (fig. 49).—Upper head hairs two to four, lower two to three. Lateral abdominal hairs

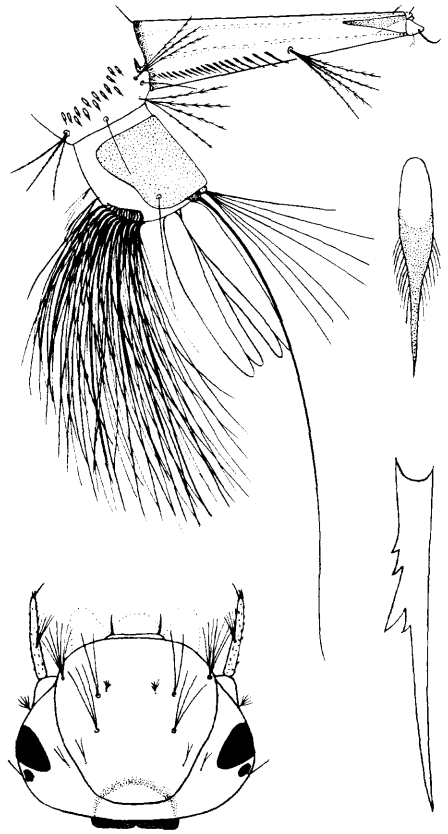

PN-856

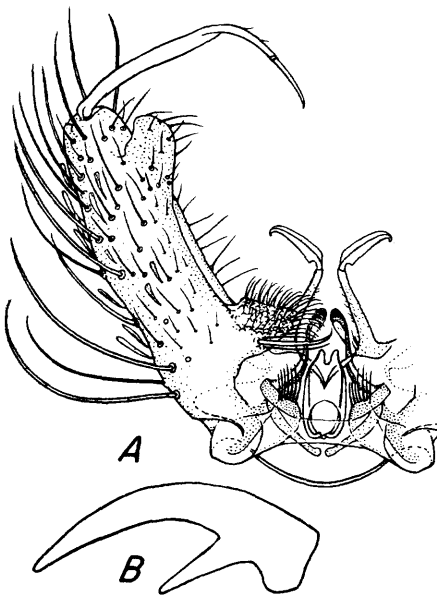
FIGURE 49.—*Aedes fitchii* larva.

PN-855

FIGURE 48.—*Aedes fitchii*: A, Male genitalia; B, claw of female.

usually double. Comb on eighth segment with many scales in triangular patch. Air tube slender and tapering, four or more times longer than wide; closely set pecten teeth to middle of tube, occasionally with one or more teeth slightly detached, tuft of three to five long hairs set close to end of pecten; apical setae as long as lateral valve. Anal segment longer than wide, plate extending well down sides at base; anal gills long and pointed.

*Bionomics*.—This species has been collected at scattered localities from Cook Inlet north to Fort Yukon, west to Naknek, and in the northwest at Kotzebue and Kivalina, but it appears to be most numerous south of the Alaska

Range (map 8). Larvae occur in semipermanent pools overgrown with *Carex rostrata* or *Equisetum fluviatile* and are usually found in association with larvae of *Aedes excrucians*. Fourth instars have been collected at Fairbanks from May 19 to June 15 and at Anchorage between May 17 and June 3. Nowhere does the species appear to be as common as *excrucians*.

### *Aedes flavescens* (Müller)

*Culex flavescens* Müller, Fauna Insect. Fridrichsdalina, p. 87. 1764.

*Female*.—Torus with dark and light scales. Mesonotum with golden-brown scales. Lower mesepimeral bristles usually absent. Abdomen completely covered with dull-yellow scales or interspersed with irregular areas of dark scales. Wing with mixture of black and pale-yellowish scales, pale scales

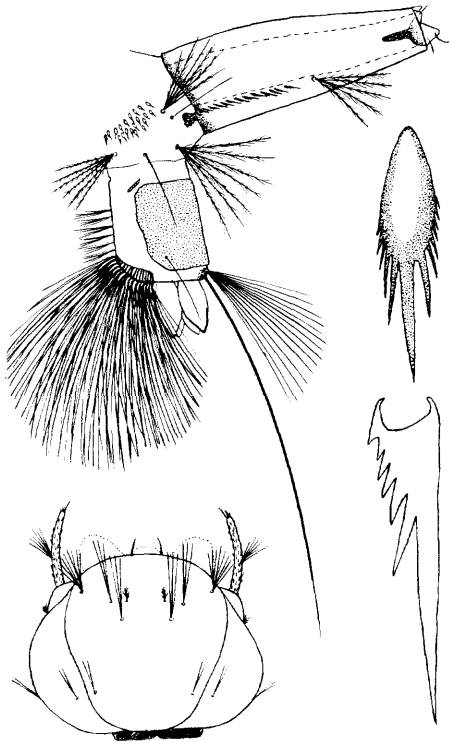

PN-858

FIGURE 51.—*Aedes flavescens* larva.

predominating from base of costa to humeral cross vein. Legs brown with mixture of yellow scales; tarsi with broad basal white bands; tarsal claw elongate with short blunt tooth (fig. 50, B).

*Male genitalia* (fig. 50, A).—Sidepieces more than two times as long as wide; apical lobe prominently rounded with many setae; basal lobe a rugose slightly elevated area with many setae, stout spine, and several long setae near base, lobe extending nearly to base of apical lobe. Claspette lightly hirsute with three stout setae on inner margin of base; filament angularly expanded to rounded point near base.

*Larva* (fig. 51).—Upper head hairs usually three to four, lower usually double. Comb on eighth segment with about 20 to 28 scales, each scale with long central spine and small basal spinules. Air tube

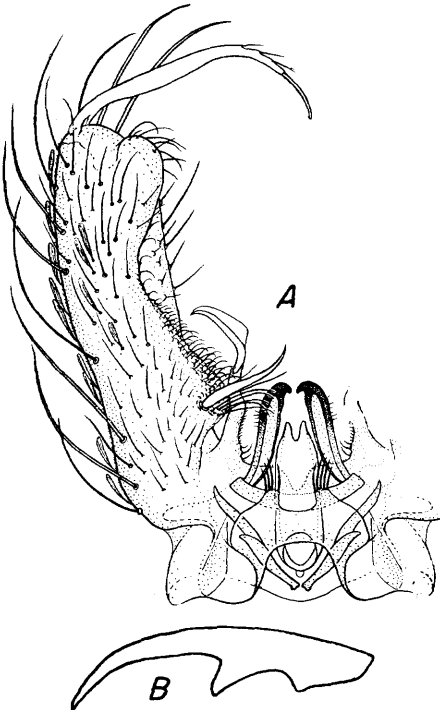

PN-857

FIGURE 50.—*Aedes flavescens*: A, Male genitalia; B, claw of female.

tapering, about  $3 \times 1$ ; pecten reaching nearly to middle with or without one or two detached teeth. Anal segment slightly longer than wide; anal gills about as long as segment.

*Bionomics*.—In Alaska this species is known only from the Cook Inlet area, where it may be locally abundant on or near tidal flats (map 7). Larvae occur in shallow pools containing emergent *Triglochin* and *Scirpus*. The pools originate from melting snow and ice but may be maintained by seepage and may be covered by the highest summer tides. In 1948 fourth-stage larvae were most numerous about June 8. Adults were prevalent from June 14 through July 31 and persisted in reduced numbers through August 18.

### *Aedes hexodontus* Dyar

*Aedes hexodontus* Dyar, Insector Insectariae Menstruus 4: 83. 1916.

*Female*.—Mesonotum yellowish to light golden brown with paired dark-brown lines and posterior half lines. Postpronotum with setae in single or irregular double row along posterior margin. Postcoxal scales present. Sternopleuron with scales extending to frontal border. Scutellum with yellow or bronzy bristles. Probasisternum with white scales on posterior part. Lower mesepimeral bristles two or three. Abdomen black with basal segmental white bands. Wings dark scaled with patch of two or three to many pale scales at base of costa. Legs black with femora partially pale scaled.

*Aedes hexodontus* as described above has not been found in Alaska but has been taken as far north as Prince Rupert, British Columbia. Knight (80) stated that *hexodontus* "appears to have at least two general varieties that are based on both adult (female) and larval characters," but concludes that more lar-

val associated females will be needed to establish the validity of these two forms.

In the "tundra" variety taken at Umiat the mesonotum is brown and the "darker markings are absent or poorly demarcated." The wings usually have a patch of white scales on the costa. Other characters are the same as described above.

*Male genitalia* (fig. 64, p. 67).—Sidepieces three times as long as broad; apical lobe long and rounded with short curved setae; basal lobe flatly conical with numerous setae and long curving spine near base. Claspette pilose, slightly curved, and expanded near middle; filament shorter than stem, slightly expanded at middle, and terminating in curved point. The characters of the male genitalia of this species are the same as those of *A. punctator*.

*Larva* (fig. 52).—Upper and lower head hairs single to triple. Lateral abdominal hairs single to triple on first to sixth segment or rarely four to six branched on

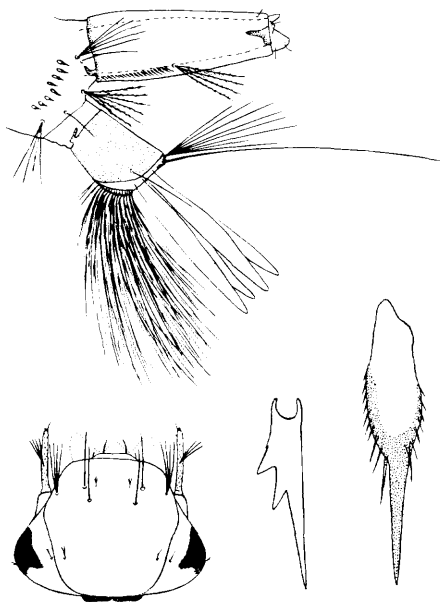

PN-859

FIGURE 52.—*Aedes hexodontus* larva.

second segment. Comb on eighth segment with 5 to 9 or rarely 10 scales in row. Air tube  $3 \times 1$ ; pecten not quite reaching middle of tube. Anal segment ringed by plate or very narrowly open ventrally.

*Bionomics.*—This is typically a tundra species, which is common in northern and northwestern Alaska and south along the Bering Sea to Naknek (map 7). It is also present in the Alaska Range and Chugach Mountains above or at least near the tree line. Larvae prefer semipermanent pools in *Carex* or *Calamagrostis* marshes and are often taken in association with larvae of *Aedes pullatus*, *communis*, and occasionally *impiger* or *punctor*. Larvae of *hexodontus* resemble *punctor* very closely, but whenever the two were collected together, *hexodontus* was always more nearly mature. At Umiat, *hexodontus* larvae were always found in pure culture (Knight 81). The adults are strong fliers and remain active at wind speeds up to 10 miles an hour. This species is responsible for much of the severe mosquito annoyance prevalent in the tundra-covered areas of Alaska.

### *Aedes impiger* (Walker)

*Culex impiger* Walker, List of Dipterous Insects in Brit. Mus., pt. I, p. 6. 1848.

*Aedes nearcticus* Dyar, Canad. Arctic Exped. Rpt. 3(C), p. 32. 1919.

*Aedes impiger*, Vockeroth, Canad. Ent. 86: 109. 1954.

Not *impiger* of authors.

*Female.*—Mesonotum black and sparsely covered with bronzy-brown scales with or without mixture of yellowish-white scales around sides, entire surface with many black bristles. Postpronotum with scales scattered over posterior half. Postcoxal scale patch present. Lower mesepimeral bristles three to eight. Abdomen black with basal segmental white bands. Wing scales dark with pale scales extending

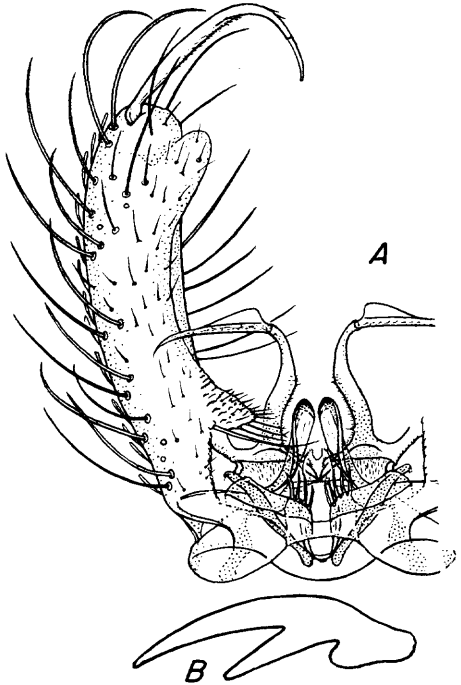

PN-860

FIGURE 53.—*Aedes impiger*: A, Male genitalia; B, claw of female.

from base of costa to humeral cross vein. Legs black with femora and tibiae partially pale scaled; tarsal claw sharply bent with slender tooth (fig. 53, B).

*Male genitalia* (fig. 53, A).—Sidepieces about  $3\frac{1}{2}$  times as long as wide; apical lobe rounded, surface with few small setae; basal lobe conically sloped to basal edge with long setae and spine at margin, rest of surface bare or with few small setae. Claspette hirsute on basal half; filament angularly expanded to its maximum width near base.

Males of *impiger* and *Aedes nigripes* may be separated by the shape of the hind tarsal claw, which is the same in the males as in the females.

*Larva* (fig. 54).—Both pairs of head hairs single. Lateral abdominal hairs multiple on first segment and double on second to fifth. Comb

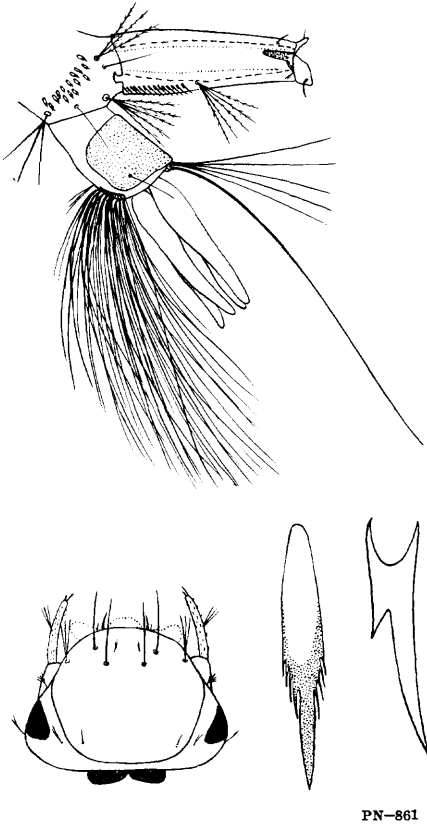

PN-861

FIGURE 54.—*Aedes impiger* larva.

on eighth segment of 8 to 16 scales, each scale with long central spine and series of smaller basal lateral spines. Air tube about  $2\frac{1}{2} \times 1$ ; pecten equally spaced on basal third and followed by multiple tuft. Anal segment as long as wide; anal gills stout and several times length of segment.

**Bionomics.**—This is typically a tundra species common in northwestern and northern Alaska (map 8). Larvae have been collected at localities in the Alaska Range and Chugach Mountains well below the tree line, but it is doubtful that the species is abundant except at higher elevations. At Umiat larvae have been taken from pools in *Sphagnum*-heath bogs. Farther south collections have been made from temporary pools in *Carex* marshes.

Where *impiger* occurs, it is the first species to emerge. In 1947 emergence at Umiat started about June 22 and continued until July 7 (Jachowski and Schultz 75).

### *Aedes implicatus* Vockeroth

*Aedes implicatus* Vockeroth, Canad. Ent. 86: 110. 1954.

*Aedes impiger* of authors, not Walker.

**Female.**—Mesonotum with median oblong area of brown scales, usually in form of broad stripe or paired stripes; margins grayish white. Postpronotum with setae in single or irregular double row along posterior margin. Postcoxal scales present. Sternopleuron with scales not extending to frontal border (fig. 30, *A*, p. 44). Proboscisternum without white scales on posterior part. Lower mesepimeral bristles one to three, or rarely with none. Hypostigial spot with or without white scales. Abdomen with basal white bands. Wing scales dark with patch of two or three to many pale scales at base of costa. Legs black with femora pale beneath.

**Male genitalia** (fig. 55).—Sidepieces about four times as long as wide. Filament of claspette angularly expanded to sharp point at base. Other characters as in *Aedes cataphylla*, page 49.

**Larva** (fig. 56).—Antennae short and spined. Upper and lower head hairs single. Lateral abdominal hairs double on first to fourth segment and single on fifth and sixth. Comb on eighth segment with 15 to 25 scales, each scale with median spine and lateral basal fringe of slightly smaller ones. Air tube about  $2\frac{1}{2} \times 1$ ; closely set pecten teeth not reaching middle and followed by tuft of three or four hairs. Anal segment longer than wide, plate extending well down sides and covered with minute spines; anal gills one to two times as long as segment.

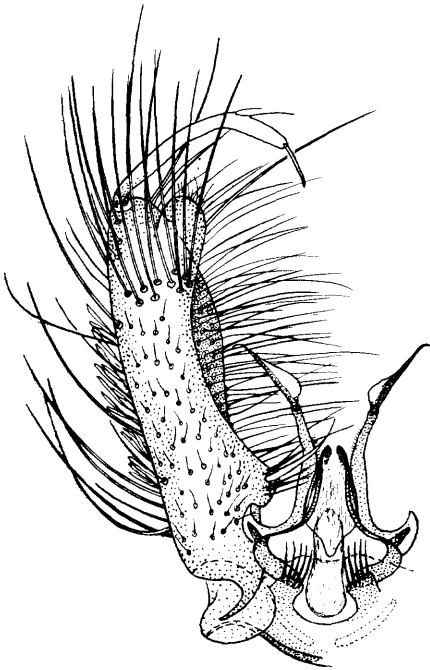

PN-862

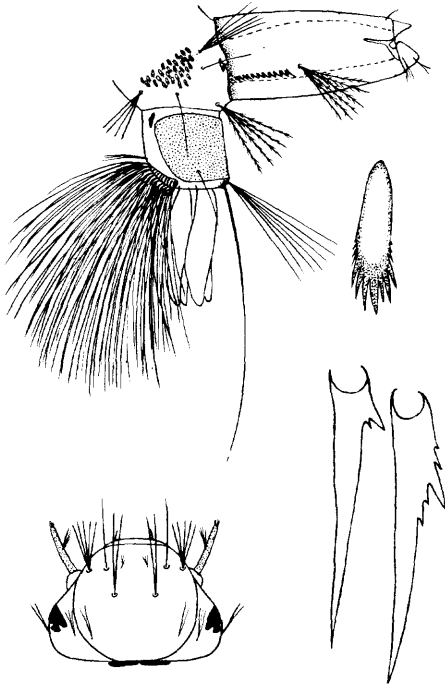
FIGURE 55.—*Aedes implicatus* male genitalia.

PN-863

FIGURE 56.—*Aedes implicatus* larva.

*Bionomics.*—This species is common in central Alaska (map 3). It has been recorded from as far south as Juneau and from Kotzebue in the northwest. It breeds in a variety of temporary pools, and it appears to be the first species in the succession series. Adult emergence reaches a peak at Fairbanks near the end of May and 2 to 3 weeks earlier at Anchorage. During 1948 it was thought to be the fourth most numerous species at Fairbanks, where it was observed to be active and biting when the sun was bright and the temperature above 80° F. At such times it was frequently the only dark-legged *Aedes* in flight.

### *Aedes intrudens* Dyar

*Aedes intrudens* Dyar, Insector Inscitiae Menstruus 7: 23. 1919.

*Female.*—Flagellum without white scales on ventral side of first segment. Mesonotum bronzy brown with gray scales around margins and rarely with indications of median brown stripes. Postcoxal scale patch absent. Sternopleuron with scales not extending to frontal border. Posterior part of probasisternum bare. Lower mesepimeral bristles none to four. Hypostigial spot of scales present or absent. Abdomen black with broad basal white bands. Wing scales dark with or without small patch of pale scales at base of costa. Legs with mixture of pale and dark scales; tarsi mostly black.

*Male genitalia* (fig. 57).—Side-pieces about three times as long as wide; apical lobe prominently rounded with numerous rather long setae; basal lobe represented by large spine at base of one side and two spines on raised projection on other. Claspette with basal half hirsute and forming sharp projection ending in stout setae at middle, apical half slender; filament angu-

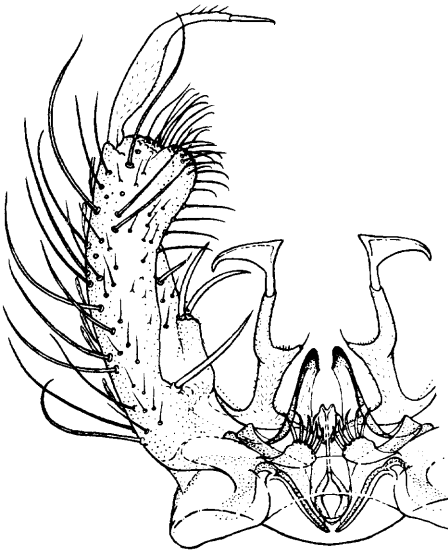

PN-864

FIGURE 57.—*Aedes intrudens* male genitalia.

larly expanded to sharp point at middle.

*Larva* (fig. 58).—Antennae shorter than head. Upper head hairs usually four, lower two or three. Lateral abdominal hairs double on first segment and single on second to sixth. Comb on eighth segment of 10 to 16 scales, each scale with long median spine. Air tube  $2\frac{1}{2} \times 1$ ; pecten reaching middle with two or three detached teeth followed by tuft of five to seven hairs; apical setae barely discernible. Anal segment longer than wide, plate extending to near ventral line and ventral margin deeply incised; anal gills short and bluntly pointed.

*Bionomics*.—This is believed to be an important pest species in the Tanana watershed of central Alaska (map 5). Only a few larvae have been found near Anchorage. Temporary snowmelt pools in the more open areas of black spruce muskeg are preferred larval habitats. Such pools are usually overgrown with *Carex* or *Calamagrostis* and are the most shallow and of

shortest duration of the pools in which mosquito larvae can be found. At Fairbanks in 1948 peak abundance of fourth-stage larvae was reached about May 26, and the pools were dry in advance of peak emergence for either *Aedes communis* or *punctator*. Larval population density seldom exceeded two per selected dip, but the vast number of pools in which larva could develop suggested that the adult population of *intrudens* might exceed that of *communis* or *punctator*, which originated from more congested larval populations restricted to the relatively small number of pools that persisted after June 5. Adult collections made in 1948 and subsequent years when the pools that produce *intrudens* were dry before the end of May confirmed the relatively greater abundance of *intrudens* in 1948.

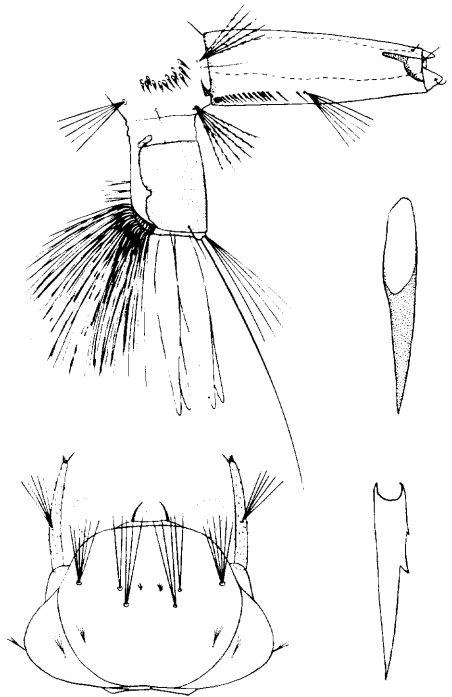

PN-865

FIGURE 58.—*Aedes intrudens* larva.

***Aedes nigripes* (Zetterstedt)**

*Culex nigripes* Zetterstedt, *Insecta Lapponica*, p. 807. 1838.

*Aedes alpinus* of authors (not Linnaeus).

*Female*.—Mesonotum black, sparsely covered with bronzy-brown scales or rarely with indications of median dark lines, sides with or without yellowish-white scales, entire surface covered with many black bristles. Postcoxal scale patch present. Lower mesepimeral bristles one to five. Abdomen black with basal segmental white bands. Wing scales dark with pale scales extending from base of costa to humeral cross vein. Legs black with femora and tibia partially pale scaled; fore tarsal claw with tooth about one-fourth as long as claw and not parallel (fig. 59, *B*).

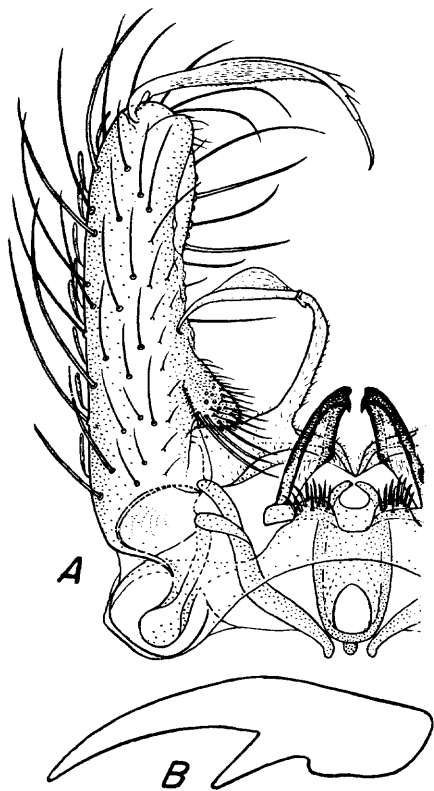

PN-866

FIGURE 59.—*Aedes nigripes*: A, Male genitalia; B, claw of female.

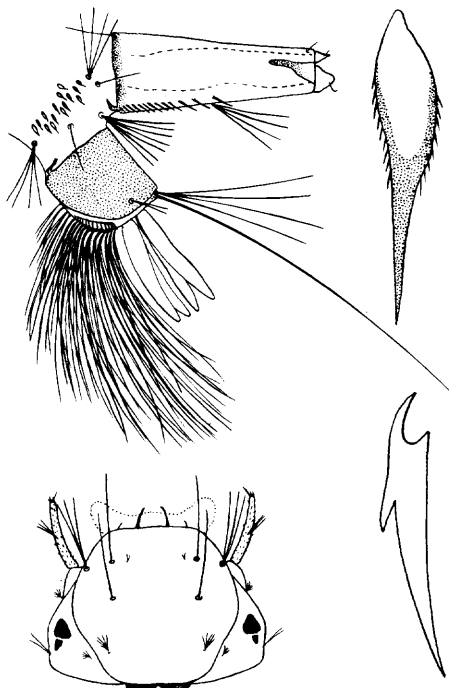

PN-867

FIGURE 60.—*Aedes nigripes* larva.

*Male genitalia* (fig. 59, *A*).—Sidepieces over three times as long as wide; apical lobe small with few short fine setae; basal lobe conically sloped to basal edge with large spinelike setae on outer margin and smaller ones on inner part. Clasper hirsute except on curved apex; filament about same length as stem, roundly expanded and ending in curved point.

*Larva* (fig. 60).—Upper and lower head hairs single. Lateral abdominal hairs multiple on first and second segments and double on third to seventh. Comb on eighth segment with 15 to 18 scales. Air tube about  $2\frac{1}{2} \times 1$ ; pecten reaching beyond middle, last three teeth detached, hair tuft basad of last pecten tooth. Anal segment ringed by plate; anal gills longer than segment.

*Bionomics*.—This is a typical tundra species, common along the coast from Teller north to Point



Barrow and on the arctic side of the Brooks Range (map 9). It is the only species so far known from Point Barrow. Larvae have been collected near Summit Lake in the Alaska Range and at Thompson's Pass in the Chugach Mountains. From these records it appears likely that *nigripes* occurs rather generally in mountain localities above the tree line. It is one of the three or four species that contribute to the mosquito problem in northern Alaska.

### *Aedes pionips* Dyar

*Aedes pionips* Dyar, Insector Inscitiae Menstruus 7: 19. 1919.

*Female*.—Mesonotum with dull-yellow or white scales, two broad well-defined dark-brown stripes and posterior half lines, median stripes separated by line of pale scales. Postpronotum with setae in single or irregular double row along posterior margin. Postcoxal scales present. Scutellum with both dark and light-colored bristles. Probasisternum with white scales on posterior part. Lower mesepimeral bristles one to four, or rarely with none. Abdomen with or without narrow basal white bands. Wing scales dark with small patch of pale scales at base of costa. Legs black with femora partially pale scaled.

*Male genitalia*.—The sidepieces are slightly longer than those of *Aedes communis* (fig. 40, p. 52). There are no other taxonomic differences in the genitalia of these two species.

The presence of the postcoxal scale patch in *pionips* males may be used to separate them from the *communis* males in which the patch is absent.

*Larva* (fig. 61).—Antennae long and well spined. Upper head hairs usually five, lower four. Comb on eighth segment with 60 to 70 scales, each scale with even fringes of spinules. Air tube about  $2\frac{1}{2} \times 1$ ;

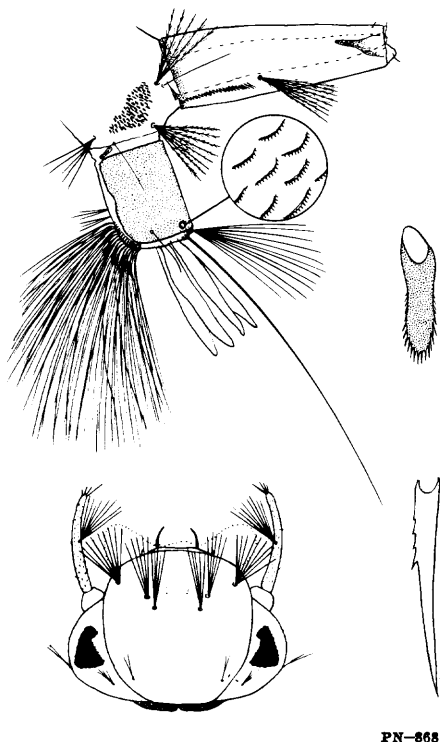

FIGURE 61.—*Aedes pionips* larva.

pecten evenly spaced, not reaching middle and followed by large multiple tuft. Anal segment about as long as wide, with plate reaching only about half distance down sides and with notched lateral edges, spines on apex of anal plate short and slender; anal gills longer than segment.

*Bionomics*.—This species is widely distributed throughout the forested lowlands from Cook Inlet north to the Yukon River (map 6). In the northwest it has been collected beyond the tree line at Kivalina. Larvae have been found often in temporary or semipermanent pools in *Sphagnum*-heath bogs, roadside ditches, tractor tracks, and other small shallow bodies of water in recently disturbed ground. The species is rather common near Anchorage but rare north of the Alaska Range. Fourth-stage larvae have been collected at Fairbanks be-

tween May 28 and June 13 and at Anchorage from May 15 to July 27. Peak adult emergence occurs from 8 to 10 days later than that of *communis*.

### *Aedes pullatus* (Coquillett)

*Culex pullatus* Coquillett, Wash. Ent. Soc. Proc. 6: 168. 1904.

*Female*.—Mesonotum with pale-yellowish to yellowish-brown scales, two median stripes being sometimes indistinct or absent. Postpronotum with setae in single or irregular double row. Postcoxal scale patch absent. Sternopleuron with scales not extending to frontal border. Probasisternum bare. Lower mesoepimeral bristles one to five. Hypostigial spot of many white scales. Abdomen black with basal white bands. Wings dark scaled with line of pale scales extending from base of costa to humeral cross vein. Legs black with femora and tibiae partially pale scaled.

*Male genitalia* (fig. 62).—Sidepieces about  $3\frac{1}{2}$  times as long as wide; apical lobe prominent and

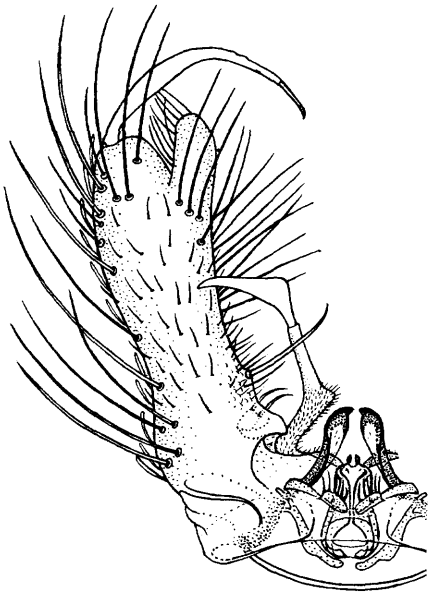

FIGURE 62.—*Aedes pullatus* male genitalia.

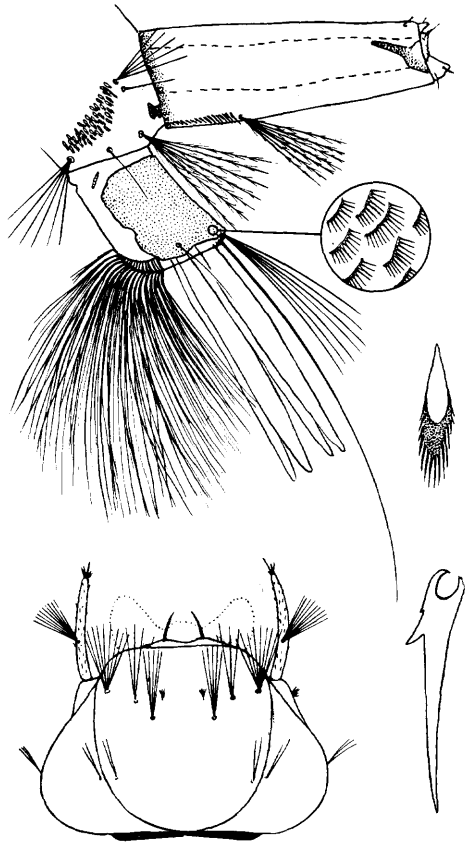

FIGURE 63.—*Aedes pullatus* larva.

somewhat elongated, ventral surface covered with numerous setae; basal lobe represented by large spine at margin and two adjacent smaller spines. Claspette with basal half large, hirsute, and forming rounded projection at middle, apical half slender; filament angularly expanded to rounded point near middle.

*Larva* (fig. 63).—Upper head hairs three to six, lower two to four, hairs short and tufts set close together. Lateral abdominal hairs long and double or triple on first to fifth segment and single on sixth. Comb on eighth segment with many scales in triangular patch. Air tube  $3 \times 1$ ; pecten teeth closely set, not reaching middle, closely fol-

owed by large 6- to 7-haired tuft; apical setae shorter than lateral valve. Anal segment longer than wide, not ringed by plate, spines on apex of anal plate long and slender; anal gills usually two or three times longer than anal segment.

*Bionomics.*—This species is found throughout Alaska in areas near the tree line; however, larvae have been collected at Wrangell and Valdez at near sea level (map 4). Small clear snowmelt pools in *Carex* meadows produce larvae in greatest numbers. The degree of development shown by associated larvae, and Frohne's observation (38) that larvae were abundant in pools in McKinley Park when swarms of male *Aedes communis* and *impiger* were already present, indicate that *pullatus* emerges somewhat later than *hexodontus*, *punctor*, *impiger*, and *communis*. Records suggest that *pullatus* is one of the most important pest species in the Chugach Mountains and Alaska Range at elevations above 2,000 feet.

### *Aedes punctor* (Kirby)

*Culex punctor* Kirby, Fauna Boreali-Amer., pt. 4, p. 309. 1837.

*Aedes cycloceroulus* Dyar, Insector Incitiae Menstruus 8: 23. 1920.

*Aedes leuconotips* Dyar, ibid 8: 24. 1920.

*Aedes punctodes* Dyar, ibid 10: 2. 1922.

*Female.*—Torus light brown to black. Mesonotum pale yellow to yellowish brown with paired dark-brown stripes and posterior submedian half stripes present or absent. Postpronotum with setae in single or irregular double row along posterior margin. Postcoxal scales present. Sternopleuron with scales extending to frontal border. Probasisternum with few or no scales. Abdomen black with basal segmental white bands. Wings completely dark scaled or with few pale scales at base of costa. Legs black, femora and tibia with or without scattered pale scales.

The taxonomic status of *punctor* is confused by the existence of a remarkable variation of structure in the larvae and of color and scale pattern in the adults. Larvae of the form prevalent along the southern coast are smaller, the anal plate does not form a complete ring, and the anal gills are short. This form has been treated by Knight (31) and Frohne (31) as a distinct species, *punctodes* Dyar. However, there is so much intergradation of the distinguishing characters that we have chosen to treat *punctodes* as a synonym of *punctor*. Among the adults there is also an apparent difference, which distinguishes the tundra populations from those of the forested areas. The "tundra" variety has the torus all dark and the mesonotum brown scaled, with darker markings absent or nearly so. The form from the forested area as described above has the torus paler laterally and the yellowish mesonotum marked with paired brown stripes.

*Male genitalia* (fig. 64).—The characters of the male genitalia of



PN-871

FIGURE 64.—*Aedes punctor* male genitalia.

this species are the same as those of *Aedes hexodontus*, page 59.

*Larva* (fig. 65).—Antennae short and spined. Upper and lower head hairs single or double. Lateral abdominal hairs usually single or double on first to sixth segments. Comb on eighth segment with 10 to 19 stout scales in irregular row. Air tube  $2\frac{1}{2} \times 1$ ; pecten fine and not reaching middle of tube, tuft centrally placed. Anal segment ringed by plate or narrowly open ventrally; anal gills  $1\frac{1}{2}$  to 3 times as long as anal plate.

*Bionomics*.—The typical variety of *punctor* is common throughout the forested areas of central Alaska, and the "tundra" variety has been taken at Umiat, Kotzebue, and Naknek (map 2). The *punctodes* form is abundant in the coastal area from Cook Inlet southeastward at least as far as Juneau. Over most

of central Alaska *punctor* is one of the species most frequently encountered in larval collections. Shallow semipermanent pools in *Sphagnum*-heath bogs and *Carex* or *Calamagrostis* marshes are favored larval habitats. Population densities are often as high as 300 per dip. In southern and central Alaska larvae were usually found associated with those of *Aedes communis* and *pionips*. At Umiat, Knight (81) found larvae of the "tundra" variety in *Sphagnum*-heath pools, which otherwise contained only *Aedes nearcticus*. Frohne (36) reported that larvae of the "tundra" variety of *punctor* were more numerous than those of any of the other species found at Naknek during May and June of 1954 and that hatching started on April 23. In 1948 fourth-stage larvae of the typical variety were collected from May 10 through September 15, with peak abundance during the first half of June. At Fairbanks fourth-stage larvae were found from May 24 through July 19, with peak abundance about June 5. At Umiat, Knight (81) observed peak abundance near the end of June.

### *Aedes riparius* Dyar and Knab

*Aedes riparius* Dyar and Knab, N.Y.  
Ent. Soc. Jour. 15: 213. 1907.

*Female*.—Torus with inner surface predominantly dark scaled. Mesonotum with golden-brown scales and few yellowish-white scales around margins. Mesepimeral bristles absent. Abdomen usually with evenly intermingled dark and white scales with or without partial basal white bands; venter white scaled or with irregular dark-scaled medium areas. Wings predominantly dark scaled with pale scales intermixed. Femora, tibiae, and first tarsal segments largely pale scaled, tarsi with basal white bands, which are broader on

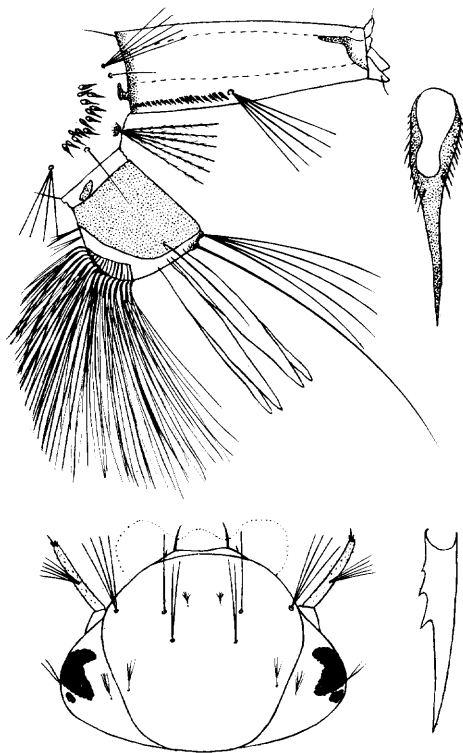

FN-872

FIGURE 65.—*Aedes punctor* larva.

hind legs; tarsal claw with short tooth not parallel with claw (fig. 66, B).

*Male genitalia* (fig. 66, A).—Sidepieces about three times as long as wide; apical lobe prominent and rounded with many curved setae; basal lobe projected in long cone shape at right angles to sidepiece, surface with many setae apically and stout spine at margin with long setae adjacent to it. Claspette lightly hirsute; filament angularly expanded to its maximum width near base.

*Larva* (fig. 67).—Antennae shorter than head. Both pairs of head hairs usually double. Comb on eighth segment with seven or eight thornlike scales in irregular row. Air tube about  $3 \times 1$ ; pecten reaching nearly to middle with last two teeth detached and followed by three-haired tuft; apical setae barely discernible. Anal segment with plate nearly reaching ventral line near base; anal gills short and pointed.

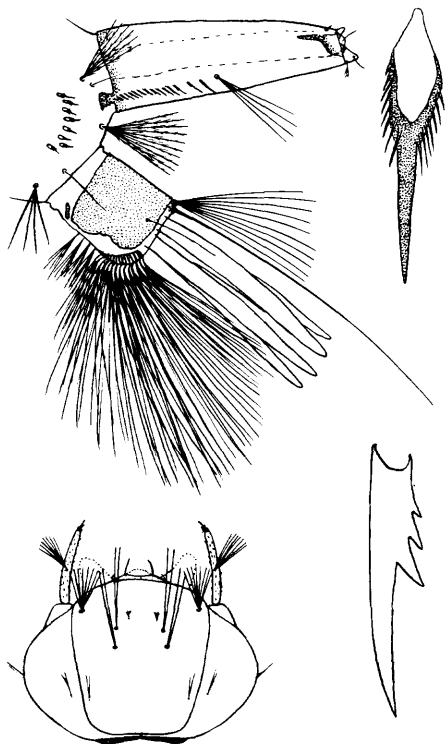

PN-874

FIGURE 67.—*Aedes riparius* larva.

*Bionomics*.—Records for this species are based on adults collected at several localities in the Yukon basin of central Alaska (map 7). It appears to be a rare species found in the vicinity of black spruce muskeg. Its large size and golden color make it conspicuous among the innumerable smaller dark *Aedes*.

### *Aedes stimulans* (Walker)

*Culex stimulans* Walker, List of Dipterous Insects in Brit. Mus., pt. I, p. 4. 1848.

*Female*.—Torus with or without white scales on dorsal half. Mesonotum yellowish white to light brown with broad median brown stripe of variable pattern of brown and light scales. Lower mesepimeral bristles three or four,

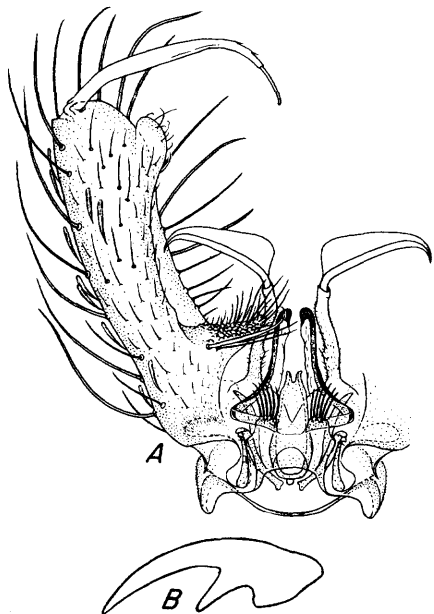

PN-873

FIGURE 66.—*Aedes riparius*: A, Male genitalia; B, female claw.

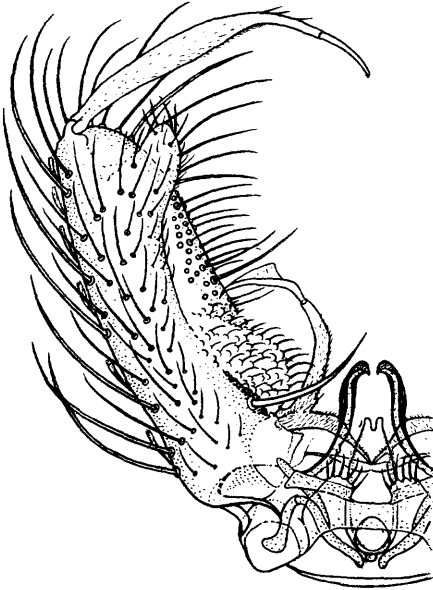

PN-875

FIGURE 68.—*Aedes stimulans* male genitalia.

rarely one or two. Abdomen black with basal segmental white bands. Wings completely dark scaled or with admixture of white ones along costa. Legs black, tarsi with basal white bands on all except last two segments of fore tarsus and first segment of midtarsus, white bands broader on hind legs; tarsal claw with short tooth not parallel to claw.

*Male genitalia* (fig. 68).—Side-pieces about three times as long as wide; apical lobe with rather long setae; basal lobe low rounded with many short setae and stout marginal spine. Claspette hirsute except at apex; filament thin and angularly expanded to sharp point at middle.

*Larva* (fig. 69).—Upper head hairs three or four, lower two or three. Mesothoracic hair No. 1 double or triple. Comb on eighth segment with about 22 to 35 scales, each scale with median spine and series of smaller lateral ones. Air

tube about  $3 \times 1$ ; pecten teeth extending nearly to middle; apical setae shorter than lateral valve. Anal segment longer than wide with plate extending well down sides; anal gills about as long as segment.

*Aedes stimulans* larvae taken in Alaska have three or four upper and two lower head hairs instead of two upper and one lower as in *stimulans* larvae taken farther south. Dyar described larvae having the larger number of head hairs as *Aedes mercurator*, but this species has since been considered a synonym of *stimulans* by Dyar and other authors.

*Bionomics*.—This species is rather common near Fairbanks and has been taken at several localities between the Chugach Mountains and Alaska Range (map 6). Larvae are found in semipermanent pools overgrown with *Equisetum fluviatile* or *Potentilla palustris*. Fourth-stage larvae have been collected at Fair-

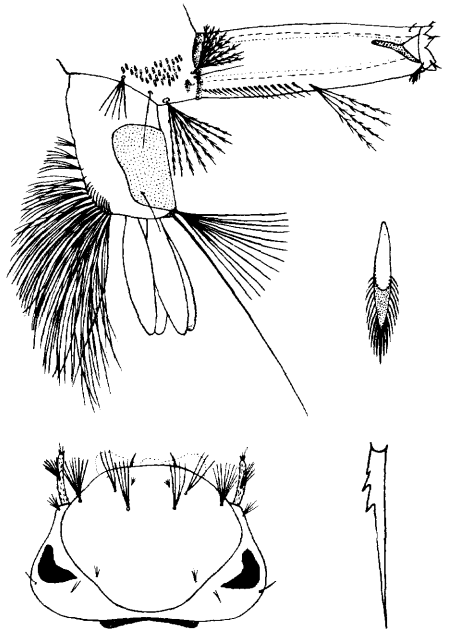

PN-876

FIGURE 69.—*Aedes stimulans* larva.

banks between June 3 and 12. The development period coincides with that of *Aedes punctator*, and data obtained in 1948 indicate that adult emergence is virtually complete before the two other band-legged species, *Aedes excrucians* and *fitchii*, reach peak emergence.

## GENUS CULISETA FELT

### KEYS TO SPECIES

#### *Adults*

- |   |                            |
|---|----------------------------|
| 1. Femora with distinct subapical white rings .....   | <i>particeps</i> , p. 75   |
| Femora without subapical white rings .....  | 2                          |
| 2. Sternopleuron with scales extending to frontal border; torus with white scales .....           | 3                          |
| Sternopleuron with white scales not extending to frontal border; torus without white scales ..... | 4                          |
| 3. Tarsi with narrow white rings on some segments; cross veins without scales .....               | <i>incidens</i> , p. 74    |
| Tarsi with broad white rings; cross veins with scales .....                                       | <i>alaskaensis</i> , p. 72 |
| 4. Tarsi with pale-white rings at both ends of tarsal joints; wings without spots .....           | <i>morsitans</i> , p. 76   |
| Tarsi without white rings; wings with faint spots .....   | <i>impatiens</i> , p. 73   |

#### *Larvae*

- |   |                            |
|---|----------------------------|
| 1. Air tube with normal pecten teeth on basal fourth not followed by long hairs .....   | <i>morsitans</i> , p. 76   |
| Air tube with normal pecten teeth near base followed by series of long hairs extending beyond middle .....  | 2                          |
| 2. Upper and lower head hairs multiple and about equal in number and length .....   | <i>impatiens</i> , p. 73   |
| Upper head hairs short and multiple, lower longer and less numerous .....   | 3                          |
| 3. Postelypeal hairs four to five branched and about as large as head hairs; posterior margin of anal plate with short spines at apex near dorsal brush ..... | <i>particeps</i> , p. 75   |
| Postelypeal hairs smaller and more delicate than head hairs; anal plate without spines .....  | 4                          |
| 4. Antennae pigmented and prominently spined; anal plate pierced by two or three tufts .....  | <i>alaskaensis</i> , p. 72 |
| Antennae not pigmented and not prominently spined; anal plate either without or pierced by one or two tufts .....   | <i>incidens</i> , p. 74    |

#### *Male Genitalia*

- |   |                            |
|---|----------------------------|
| 1. Apical lobe absent .....   | <i>morsitans</i> , p. 76   |
| Apical lobe present .....   | 2                          |
| 2. Eighth segment with row of 20 to 40 short spines on basal margin; basal lobe large with single spinelike setae ..... | <i>impatiens</i> , p. 73   |
| Eighth segment with less than 12 spines on basal margin; basal lobe with 2 or 3 spines .....                            | 3                          |
| 3. Apical lobe with many setae and one spine .....  | <i>incidens</i> , p. 74    |
| Apical lobe with setae only .....   | 4                          |
| 4. Eighth segment without spines or with single short spine at center of basal margin .....                             | <i>particeps</i> , p. 75   |
| Eighth segment with about eight stout spines .....  | <i>alaskaensis</i> , p. 72 |

*Culiseta alaskaensis* (Ludlow)

*Theobaldia alaskaensis* Ludlow, Canad. Ent. 38: 326. 1906.

*Female* (frontispiece).—Torus white scaled. Flagellum with first segment white scaled ventrally. Mesonotum with even mixture of brown and white scales, sometimes marked with pair of median white spots. Sternopleuron with scales extending to frontal border. Abdomen black with basal segmental white bands. Wing scales dark, scales forming spots at base and fork of second vein, along cross veins, at base and fork of fourth, upper fork of fifth, and middle of sixth veins. Legs black with wide basal white bands that are broadest on hind legs.

*Male genitalia* (fig. 70).—Side-pieces more than twice as long as wide; apical lobe a low rounded area densely covered with small setae; basal lobe large, conical, covered with small setae, apex with two

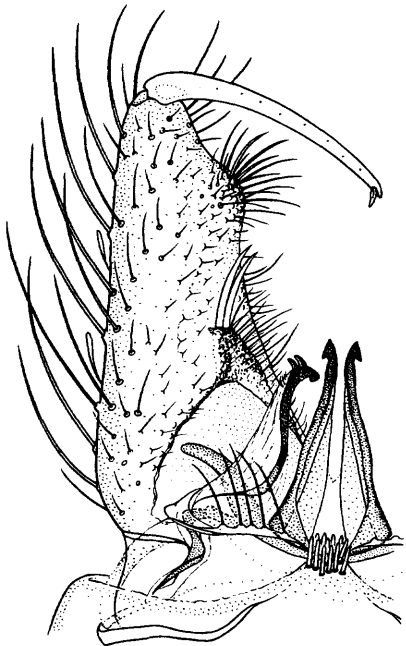

PN-877

FIGURE 70.—*Culiseta alaskaensis* male genitalia.

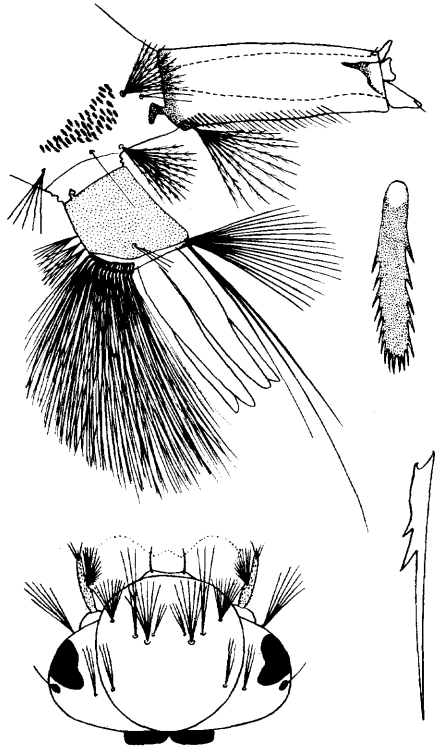

PN-878

FIGURE 71.—*Culiseta alaskaensis* larva.

stout spines. Lobes of ninth tergite broad, rounded, and bearing 7 to 10 slender setae. Eighth segment with about eight stout spines.

*Larva* (fig. 71).—Antennae pigmented, distinctly spined, and equal to or slightly shorter than distance between two antennae. Upper head hairs five or six, lower three or four. Postclypeal hairs smaller and more delicate than head hairs. Air tube  $2 \times 1$ ; 8 to 12 pecten teeth on basal fourth followed by long hairs that extend nearly to apex, paired tufts arising close to base between pecten rows. Anal segment about as long as wide, ringed by plate with two or three tufts piercing plate.

*Bionomics*.—This species is common in forested lowland areas from Haines north to the Yukon River and west to Naknek (map 12).



Larvae develop in shallow semi-permanent or permanent pools that are clogged with debris and vegetation, often in association with *Anopheles earlei*, *Culex territans*, and in the more southern part of its range with *Culiseta impatiens*. Overwintering adults appear during early April near Anchorage and in early May at Fairbanks. Activity is greatest during May and the first half of June. During 1948 fourth-stage larvae were found at both Fairbanks and Anchorage from the middle of June until mid-September. Peak abundance at both localities occurred about the second week in July. Adults emerge from late June until fall, and studies by Frohne (33) have shown that the females do not take blood meals until the following spring.

In some localities *alaskaensis* is sufficiently numerous to cause serious annoyance for a full month or even 6 weeks in advance of *Aedes* emergence. Its habit of emerging from hibernation while much of the winter snow still covers the ground has caused it, together with *impatiens*, to be known locally as "the snow mosquito."

### *Culiseta impatiens* (Walker)

*Culex impatiens* Walker, List of Dipterous Insects in Brit. Mus., pt. I, p. 5. 1848.

*Female*.—Torus and first segment of flagellum without white scales. Mesonotum with brown and yellowish scales, two fine pale lines extending posteriorly from median pale patches and variable pattern of other pale scales. Sternopleuron with scales not extending to frontal border. Abdomen black with basal segmental white bands. Wing scales brown and aggregated to form faint spots at forks of second and fourth veins and bases of second and third veins. Legs black, femora white tipped.

*Male genitalia* (fig. 72).—Side-pieces stout conical, about twice as long as wide; apical lobe a small slightly elevated chitinized area with long setae; basal lobe large and conical in outline, apex rounded with one large spinelike seta and several smaller ones. Lobes of ninth tergite only slightly separated and each bearing about 10 long setae. Eighth segment with row of 20 to 40 short stout spines on basal margin.

*Larva* (fig. 73).—Antennae slightly longer than distance between two antennae. Both pairs of head hairs multiple and long. Lateral abdominal hairs multiple on first to fifth segment and double on sixth. Air tube stout,  $2 \times 1$ ; pecten of 10 to 15 teeth on basal fourth followed by long hairs that nearly reach apex of tube, paired tufts large and arising close to base between rows of pecten. Anal segment wider than long, ringed by plate with two to three anterior

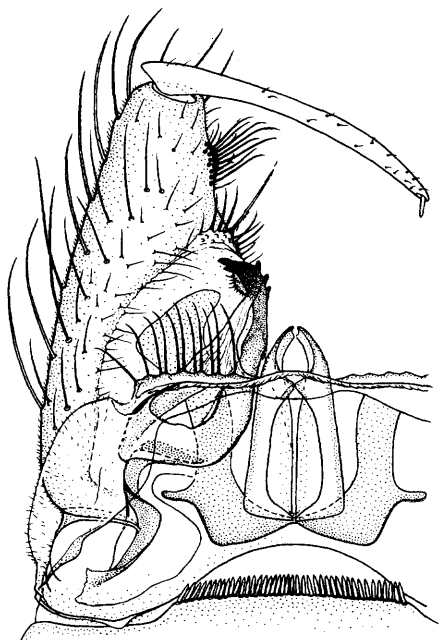

PN-879

FIGURE 72.—*Culiseta impatiens* male genitalia.

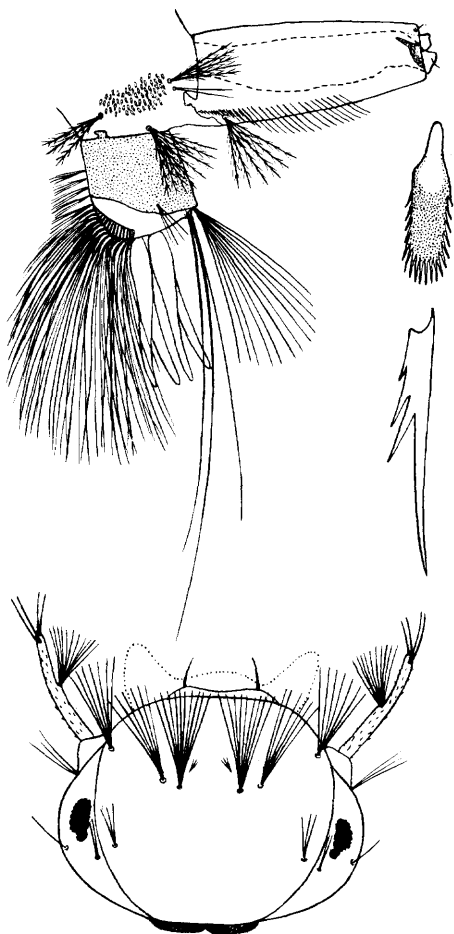

PN-880

FIGURE 73.—*Culiseta impatiens* larva.

tufts of ventral brush puncturing plate and with tuft of small hairs near posterior margin; anal gills longer than segment.

*Bionomics*.—This species occurs in the Panhandle northward to the Cook Inlet area, where it seems to be more numerous than *Culiseta alaskaensis*. In the west it has been reported from Naknek (36) and Unalakleet, and one adult has been taken at Nome (map 11). Although it occurs at Fairbanks, the species appears to be quite uncommon north of the Coast Ranges. Larvae are found in semipermanent

or permanent pools of the same kind as those described for *alaskaensis*. In fact, larvae of the two species are usually taken from the same pools, at least in the Cook Inlet area. During 1948 the peak abundance was not reached until the second week in August or almost a month later than that of *alaskaensis*. Also during 1948 no *impatiens* adults were seen prior to May 1, but they were more numerous than *alaskaensis* after May 19. Few adults were seen after the middle of June.

### *Culiseta incidens* (Thomson)

*Culex incidens* Thomson, Kongl. Sven. Freg. Resa, Dipt., v. 6, p. 443. 1868.

*Female*.—Torus white scaled. Flagellum with first segment white scaled ventrally. Mesonotum with dark-brown scales and mixture of yellowish scales, some of which form partial longitudinal lines or spots. Sternopleuron with scales extending to frontal border. Abdomen black with basal segmental white bands. Wing scales dark, aggregated into patches on fork and base of second vein, fork of second and fourth veins, upper fork of fifth and middle of sixth veins. Legs dark brown with narrow faint-white rings on bases of some of tarsal joints, femora and tibia with narrow white rings at their apices.

*Male genitalia* (fig. 74).—Side-pieces more than twice as long as wide; apical lobe a small elevated area with a number of small setae and long spine; basal lobe small and conical with small setae, apex with two stout spines. Lobes of ninth tergite slightly separated, each bearing five to eight rather long setae. Eighth segment with five to eight spines on basal margin.

*Larva* (fig. 75).—Antennae not pigmented and not prominently spined. Both pairs of head hairs

multiple, lower tufts longer and fewer in number than upper. Postclypeal hairs smaller and more delicate than head hairs. Lateral abdominal hairs multiple on first and second segments and double on third to sixth. Air tube stout, about  $2 \times 1$ ; pecten with few basal denticles, teeth followed by long hairs to apical third of tube, multiple tuft near base between rows of pecten. Anal segment ringed by plate; tufts of ventral brush absent or with one to two puncturing plate and a small one- to three-haired tuft on lateral posterior margin; anal gills slightly longer than segment.

*Bionomics*.—Larvae of this species and one adult have been collected at Juneau (Frohne 30) (map 12). Records from Matanuska (Stage and Chamberlin 99) are believed to have been in error and probably refer to *Culiseta alaskaensis*.



PN-881

FIGURE 74.—*Culiseta incidens* male genitalia.

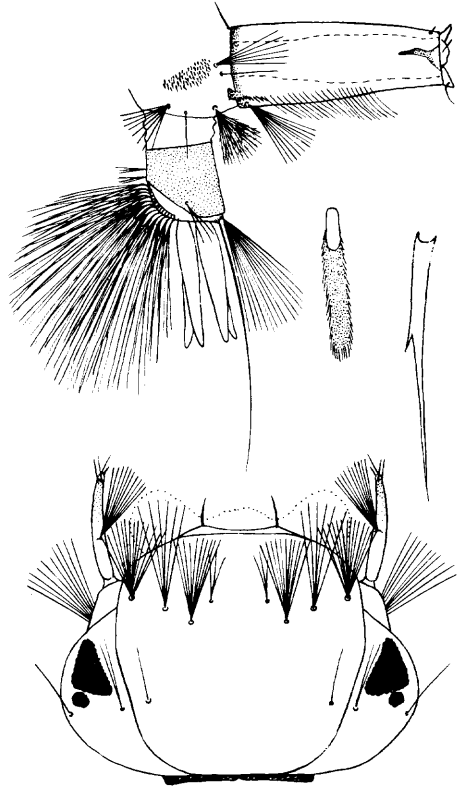

PN-882

FIGURE 75.—*Culiseta incidens* larva.

### *Culiseta particeps* (Adams)

*Culex particeps* Adams, Kans. Univ. Sci. Bul. 2, p. 26. 1903.

*Culiseta maccrackenae* Dyar and Knab, Wash. Biol. Soc. Proc. 19: 133. 1906.

*Female*.—*Mesonotum* dark brown with light-brown median stripe and narrow white posterior half lines; sides, anterior margin, and margins of antescutellar space with mixture of white scales. Abdomen black with basal segmental white bands and few scattered white scales. Wing scales black with few pale scales on costal veins, dark scales forming spots at base of second vein, forks of second and fourth veins, upper fork of fifth vein, and on cross veins. Legs black with part of inner side white

scaled, femora with subapical white ring followed by black ring, apical segments of tarsi without rings and succeeding tarsi with gradually broadening white rings.

*Male genitalia*.—Sidepieces about three times as long as wide; apical lobe a small elevated area with number of long setae; basal lobe small and conical with many small setae, apex with two or three stout spines. Lobes of ninth tergite not separated but indicated by two large groups of small spines. Eighth segment without spines or with one spine at center of basal margin.

*Larva*.—Both pairs of head hairs multiple, lower with about three long hairs, upper more numerous and shorter. Postclypeal hairs four to five branched and about as long as head hairs. Mesothoracic hair No. 3 less than six times prothoracic hair No. 0. Air tube stout, about  $2 \times 1$ ; pecten with few basal teeth followed by long hairs that extend nearly to apex of tube, paired tuft near base of tube between rows of pecten. Anal segment ringed by plate with two anterior tufts of ventral brush arising from cleft in plate and small patch of short bristles near apex of plate; anal gills slightly longer than segment.

*Bionomics*.—Larvae believed to belong to this species were collected from a roadside ditch at Wrangell (Frohne and Sleeper 42) (map 12). If they are correctly identified, this is the only record for the species north of southwestern Oregon.

### *Culiseta morsitans* (Theobald)

*Culex morsitans* Theobald, Monog. of Culicidae of World, v. II, p. 8. 1901.

*Female*.—Torus and first segment of flagellum not white scaled. Mesonotum brown with mixture of yellowish scales around margins, pair of faint nearly bare median stripes, and posterior yellowish-

white half lines. Sternopleuron with scales not extending to frontal border. Abdomen brown scaled with scattered yellowish-white scales, mostly heavily concentrated along apices and bases of segments, or these may occasionally form basal pale bands only. Wing scales dark with pale scales at base of costa. Legs dark with faint-white rings at both ends of tarsal joints.

*Male genitalia* (fig. 76).—Sidepieces conical, more than twice as long as wide; apical lobe absent; basal lobe prominent and conical with three to five spines on apex and small setae on sides. Lobes of ninth tergite with broad projections, each with 6 to 12 slender setae. Eighth segment with group of small spines centrally on basal margin.

*Larva* (fig. 77).—Upper head hairs multiple, lower double. Lat-



PN-883

FIGURE 76.—*Culiseta morsitans* male genitalia. (Courtesy A. R. Barr.)

## GENUS ANOPHELES MEIGEN

### *Anopheles earlei* Vargas

*Anopheles earlei* Vargas, Pan Amer. Union Bol. de la Ofc. Sanit. 22:8. 1943.

*Female*.—Palpi as long as proboscis, dark brown. Mesonotum with pruinose gray stripe bordered by dark bands, median stripe with hairlike yellowish scales. Wing scales dark brown and aggregated into spots at base of second vein, at forks of second and fourth veins, and at cross veins, second vein between cross veins and fork with numerous dark scales, spot of pale scales at apex of wing. Legs black, apices of femora and tibiae with pale-yellowish scales.

*Male genitalia* (fig. 78).—Claspettes bilobed, with two (sometimes three) spines on ventral lobe and usually with two spines on dorsal lobe. Claspers with bases covered with dense patch of nonpapillated hairs. Mesosome with four pairs of nonserrated leaflets. Ninth tergite

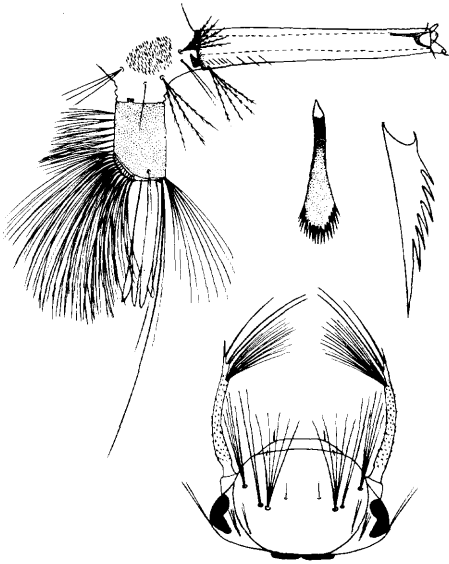

PN-884

FIGURE 77.—*Culiseta morsitans* larva.

eral abdominal hairs multiple on first and second segments, single and long on third to sixth. Air tube about  $6 \times 1$ ; pecten with six to nine teeth on basal fourth, paired tuft at base between rows of pecten. Anal segment longer than wide and ringed by plate; anal gills slender and longer than segment.

*Bionomics*.—This infrequently collected species has been recorded from scattered localities within the forest zone from Anchorage north to Fairbanks and in the southwest at Naknek (map 10). Larvae are often found associated with *Aedes excrucians* in semipermanent and permanent pools that are overgrown with *Carex rostrata*. In the Anchorage area Frohne (32) found larvae associated with *Culiseta alaskaensis* and *impatiens* in *Myrica-Sphagnum* bogs. In 1948 fourth instars were found at Fairbanks from June 15 to July 19 and at Anchorage from May 31 to August 16. Little is known concerning the biology of this species. It is not known to bite man.

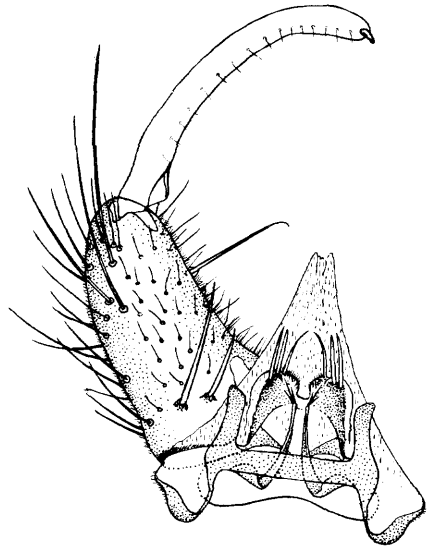

PN-885

FIGURE 78.—*Anopheles earlei* male genitalia.

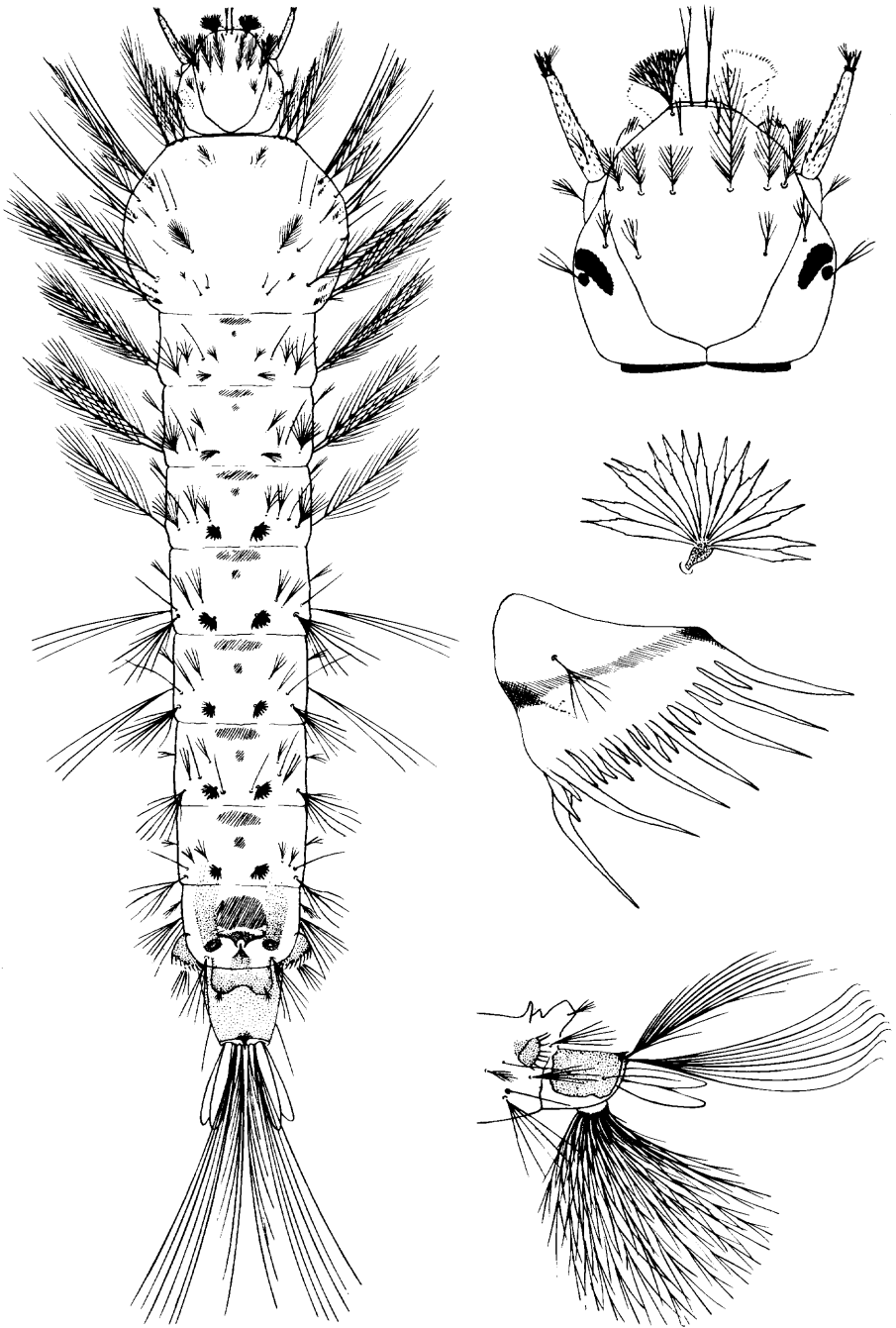

FIGURE 79.—*Anopheles carlei* larva.

with lobes usually short and with apex broadened or obliquely truncate.

*Larva* (fig. 79).—Head longer than wide. Postclypeal hairs two to five branched, branching usually short distance from base. Inner clypeal hairs bifurcate near middle or with few additional fine branches and set close together. Frontoclypeal sclerite pale banded. Abdomen with palmate tufts on third to seventh segments, antepalmate hairs on fourth and fifth segments with two to four branches. Anal segment longer than wide, dorsal plate with long single lateral hair; anal gills as long as segment and bluntly pointed.

*Bionomics*.—This rather uncommon species is widely distributed throughout the forested lowlands from Cook Inlet north to the Yukon River (map 10). Larvae live in pools and ponds or along lake shores that are permanent or dry for only a short time during the late summer. These habitats usually support an emergent cover of *Equisetum*, *Typha*, or *Carex rostrata*, and larvae are always associated with floating or partly submerged plants such as *Lemna*, *Ranunculus*, and *Utricularia*. Overwintering adults appear in early May and disappear during early June. In 1948 fourth instars were most numerous about July 1 at Fairbanks and July 7 at Anchorage. Few larvae were collected after July 10. Although the adult females bite readily, they have not been observed in numbers sufficient to cause serious annoyance. Alaskan records for *Anopheles maculipennis* and *occidentalis* refer to *earlei*. Frohne (37) has reported that although Alaskan *earlei* appears structurally similar to *earlei* of Montana, there are pronounced physiological and behavioral differences between the two populations.

## GENUS CULEX LINNAEUS

### *Culex territans* Walker

*Culex territans* Walker, Insecta Saundersiana, Diptera, v. I, p. 428. 1856.  
*Culex apicalis* Adams (of Dyar and other authors, not Adams).

*Female*.—*Mesonotum* brown scaled with median indistinct nearly bare lines and usually with two median spots of yellowish scales. Abdomen black scaled with apical segmental white bands. Wing scales all black. Legs black, undersurface partially white scaled.

*Male genitalia* (fig. 80).—Sidepieces more than twice as long as wide; subapical lobe with two large rods, spine, and five hooked

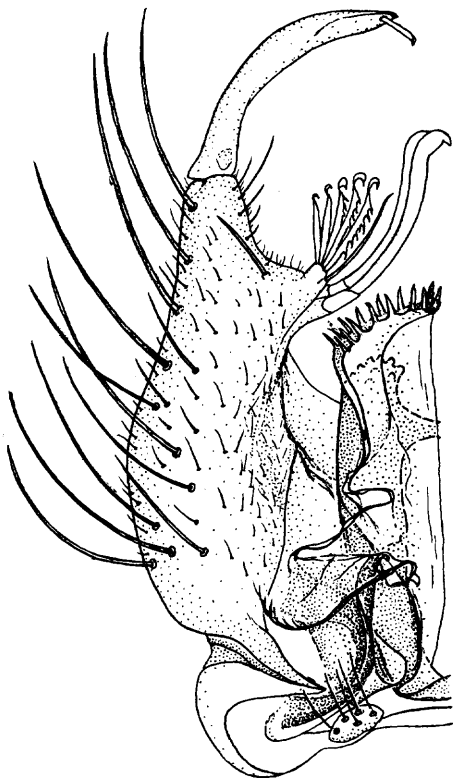

PN-887

FIGURE 80.—*Culex territans* male genitalia.

filaments, first three partially serrated. Tenth sternite prominent, apex broad, extending beyond mesosome and terminating in row of short setae. Mesosome halves with relatively even oblong outlines terminating apically in rounded serrated margin, halves joined by sclerotized band near apex.

*Larva* (fig. 81).—Antennae large, cylindrical, and spined. Head hairs single or double. Lateral abdominal hairs multiple on first and second segments and double on third to sixth, secondary hairs numerous and well developed. Comb on eighth segment with numerous scales in triangular patch. Air tube long and tapering, about  $7 \times 1$ ; pecten of 12 to 14 teeth on basal third of tube with four pairs of prominent tufts beyond pecten and also sometimes small fifth pair near apex. Anal segment ringed by plate, longer than wide.

*Bionomics*.—This species is distributed throughout the forested lowlands from Valdez and the Cook Inlet area north to the Yukon River (map 9). Larvae live in permanent or almost permanent pools and ponds as well as along lake shores. Favored habitats support an emergent cover of *Equisetum*, *Carex rostrata*, or *Scirpus validus*, contain *Ranunculus*, and often have a floating cover of *Lemna*. In 1948 fourth-stage larvae were found at Anchorage from June 16 through

August 20 and were most numerous about July 27. At Fairbanks they were taken from June 9 through September 7, with a peak abundance about July 3. Larvae are able to survive in pools containing such high populations of insect predators that all *Aedes* and *Culiseta* larvae are eliminated. Adults are seldom seen. They are known to feed on frogs.

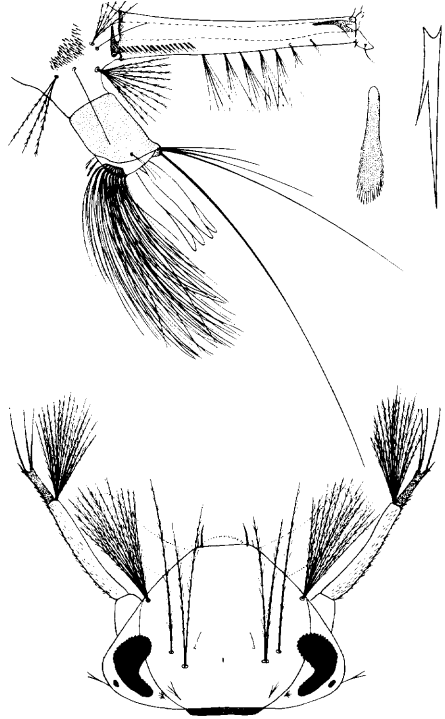

PN-888

FIGURE 81.—*Culex territans* larva.



## Literature Cited

- (1) ABERCROMBIE, W. R.  
1900. A MILITARY RECONNOISSANCE OF THE COPPER RIVER VALLEY. *In* Compilation of Narratives of Explorations in Alaska. 56th Cong., 1st Sess., Senate Rpt. No. 1023. 856 pp., illus. Wash., D.C.
- (2) ALTMAN, R. M., and SMITH, C. N.  
1955. INVESTIGATIONS OF REPELLENTS FOR PROTECTION AGAINST MOSQUITOES IN ALASKA, 1953. *Jour. Econ. Ent.* 48: 67-72.
- (3) AMERICAN MOSQUITO CONTROL ASSOCIATION.  
1948. THE USE OF AIRCRAFT IN THE CONTROL OF MOSQUITOES. *Amer. Mosquito Control Assoc. Bul.* 1, 46 pp., illus.
- (4) ———  
1952. GROUND EQUIPMENT AND INSECTICIDES FOR MOSQUITO CONTROL. *Amer. Mosquito Control Assoc. Bul.* 2, 116 pp., illus.
- (5) APPLEWHITE, K. H., and CROSS, H. F.  
1951. FURTHER STUDIES OF REPELLENTS IN ALASKA. *Jour. Econ. Ent.* 44: 19-22.
- (6) ——— KEEGAN, H. L., and HEDEEN, R. A.  
1953. RESIDUAL EFFECTIVENESS OF DDT SPRAYS AGAINST MOSQUITO BREEDING IN ALASKA. (Scientific Notes) *Jour. Econ. Ent.* 46: 516-517.
- (7) ——— and SMITH, C. N.  
1950. FIELD TESTS WITH MOSQUITO AND SAND FLY REPELLENTS IN ALASKA. *Jour. Econ. Ent.* 43: 353-357.
- (8) BACON, R. W.  
1946. EFFECTIVENESS OF INSECT WIRE SCREENING. *Mosquito News* 6: 85-88, illus.
- (9) BARBER, M. A.  
1928. THE FOOD OF CULICINE LARVAE. U.S. Treas. Dept. Pub. Health Rpts. 43: 11-17.
- (9a) BARR, A. R., and EHRlich, P. R.  
1958. MOSQUITO RECORDS FROM THE CHUKCHI SEA COAST OF NORTHWESTERN ALASKA. *Mosquito News* 18: 12-14.
- (10) BATES, M.  
1949. THE NATURAL HISTORY OF MOSQUITOES. 379 pp., illus. N.Y.
- (11) BECKEL, W. E.  
1954. THE IDENTIFICATION OF ADULT FEMALE Aedes MOSQUITOES (DIPTERA, CULICIDAE) OF THE BLACK-LEGGED GROUP TAKEN IN THE FIELD AT CHURCHILL, MANITOBA. *Canad. Jour. Zool.* 32: 324-330, illus.
- (12) ———  
1954. THE LACK OF AUTOLYSIS OF THE FLIGHT MUSCLES OF Aedes COMMUNIS (DEGEER) (CULICIDAE) IN THE LABORATORY. *Mosquito News* 14: 124-127, illus.
- (13) BIDLINGMAYER, W. L., and SCHOOF, H. F.  
1956. OUTDOOR RESIDUAL TREATMENTS OF PREMISES FOR CONTROL OF SALT-MARSH MOSQUITOES. *Mosquito News* 16: 17-19.
- (14) BLANTON, F. S., HUSMAN, C. N., TRAVIS, B. V., and WILSON, C. S.  
1949. CONTROL OF ALASKAN MOSQUITO ADULTS BY AERIAL SPRAYS. *Jour. Econ. Ent.* 42: 106-109.
- (15) ——— TRAVIS, B. V., SMITH, N., and HUSMAN, C. N.  
1950. CONTROL OF ADULT MOSQUITOES IN ALASKA WITH AERIAL SPRAYS. *Jour. Econ. Ent.* 43: 347-350.
- (16) BROWN, A. W. A., and MULHERN, T. D.  
1954. A REPORT ON TESTS OF THE PERFORMANCE OF ADULTICIDING MACHINES IN CALIFORNIA. *Mosquito News* 14: 175-186, illus.
- (17) ——— and WATSON, D. L.  
1953. STUDIES ON FINE SPRAY AND AEROSOL MACHINES FOR CONTROL OF ADULT MOSQUITOES. *Mosquito News* 13: 81-95, illus.
- (18) CARPENTER, S. J., and LACASSE, W. J.  
1955. MOSQUITOES OF NORTH AMERICA (NORTH OF MEXICO). 360 pp., illus. Los Angeles.
- (19) CHAMBERLIN, J. C., and LAWSON, F. R.  
1945. A MECHANICAL TRAP FOR THE SAMPLING OF AERIAL INSECT POPULATIONS. *Mosquito News* 5: 4-7, illus.
- (20) COQUILLET, D. W.  
1900. PAPERS FROM THE HARRIMAN ALASKA EXPEDITION IX. *Wash. Acad. Sci. Proc.* 2: 389-464.

- (21) CRAIG, G. B., JR., and PIENKOWSKI, R. L.  
1955. THE OCCURRENCE OF *Aedes canadensis* (THEOBALD) IN ALASKA. Wash. Ent. Soc. Proc. 57: 268.
- (22) CROWE, R.  
1948. THE PLUMBER'S NIGHTMARE "GROWS UP" AND NOW HAS A "COLT." Mosquito News 8: 110-111, illus.
- (23) CULVER, D., CAPLAN, P., and THIELEN, W.  
1956. CONSIDERATION OF HUMAN EXPOSURE TO MALATHION USED IN POPULATED AREAS. Mosquito News 16: 81-83, illus.
- (24) CURTIS, L.  
1954. A PORTABLE PNEUMATIC SPRAY UNIT. Mosquito News 14: 58-61, illus.
- (25) DEONIER, C. C., and GILBERT, I. H.  
1950. RESISTANCE OF SALT-MARSH MOSQUITOES TO DDT AND OTHER INSECTICIDES. Mosquito News 10: 138-143.
- (26) DICE, L. R.  
1943. THE BIOTIC PROVINCES OF NORTH AMERICA. 78 pp., illus. Ann Arbor, Mich.
- (27) DYAR, H. G.  
1928. THE MOSQUITOES OF THE AMERICAS. 616 pp., illus. Wash., D.C.
- (28) EDDY, G. W., HOPKINS, T. L., and ROBBINS, W. E.  
1958. RESISTANCE OF *Culex tarsalis* Coq. TO DDT IN OREGON. Jour. Econ. Ent. 51: 56-58.
- (29) FROHNE, W. C.  
1951. SEASONAL INCIDENCE OF MOSQUITOES IN THE UPPER COOK INLET, ALASKA. Mosquito News 11: 213-216.
- (30) ———  
1952. MOSQUITO NEWS FROM ALASKA. Mosquito News 12: 263.
- (31) ———  
1953. MOSQUITO BREEDING IN ALASKAN SALT MARSHES, WITH ESPECIAL REFERENCE TO *Aedes punctodes* Dyar. Mosquito News 13: 96-103.
- (32) ———  
1953. NATURAL HISTORY OF *Culiseta impatiens* (Wlk.), (DIPTERA, CULICIDAE), IN ALASKA. Amer. Micros. Soc. Trans. 72: 103-118.
- (33) ———  
1954. BIOLOGY OF AN ALASKAN MOSQUITO, *Culiseta alaskaensis* (Ludl.). Amer. Ent. Soc. Ann. 47: 9-24, illus.
- (34) ———  
1954. MOSQUITO DISTRIBUTION IN ALASKA WITH ESPECIAL REFERENCE TO A NEW TYPE OF LIFE CYCLE. Mosquito News 14: 10-13.
- (35) ———  
1955. CHARACTERISTIC SADDLE SPINES OF NORTHERN MOSQUITO LARVAE. Amer. Micros. Soc. Trans. 74: 295-302.
- (36) ———  
1955. TUNDRA MOSQUITOES AT NAKNEK, ALASKA PENINSULA. Amer. Micros. Soc. Trans. 74: 292-295.
- (37) ———  
1956. THE EGG AND IDENTITY OF ALASKAN ANOPHELES. Mosquito News 16: 308.
- (38) ———  
1957. RECONNAISSANCE OF MOUNTAIN MOSQUITOES IN THE MCKINLEY PARK REGION, ALASKA. Mosquito News 17: 17-22.
- (39) ——— and FROHNE, R. G.  
1952. MATING SWARMS OF MALES OF THE MOSQUITO, *Aedes punctator* (Kirby), IN ALASKA. Mosquito News 12: 248-251.
- (40) ——— and FROHNE, R. G.  
1954. BREEDING PLACES OF *Aedes pseudodiantaeus* Smith and *diantaeus* H., D., & K. IN ALASKA. Brooklyn Ent. Soc. Bul. 49: 95-99.
- (41) ——— and FROHNE, R. G.  
1954. DIURNAL SWARMS OF *Culex territans* Walker, AND THE CREPUSCULAR SWARMING OF *Aedes* ABOUT A SMALL GLADE IN ALASKA. Mosquito News 14: 62-64.
- (42) ——— and SLEEPER, D. A.  
1951. RECONNAISSANCE OF MOSQUITOES, PUNKIES, AND BLACKFLIES IN SOUTH-EAST ALASKA. Mosquito News 11: 209-213.
- (43) GAHAN, J. B., BERTHOLF, J. H., DAVIS, A. N., JR., and SMITH, C. N.  
1956. FIELD TESTS WITH TWO PHOSPHOROTHIOATES AGAINST RESISTANT SALT-MARSH MOSQUITOES. Mosquito News 16: 91-93.

- (44) GAHAN, J. B., LABRECQUE, G. C., and BOWEN, C. V.  
1955. AN APPLICATOR FOR ADDING CHEMICALS TO FLOWING WATER AT UNIFORM RATES. *Mosquito News* 15: 143-147, illus.
- (45) ——— and MULHERN, T. D.  
1955. FIELD STUDIES WITH WATER-SOLUBLE INSECTICIDES FOR THE CONTROL OF MOSQUITO LARVAE IN CALIFORNIA PASTURES. *Mosquito News* 15: 139-143, illus.
- (46) ——— and NOE, J. R.  
1955. CONTROL OF MOSQUITO LARVAE IN RICE FIELDS WITH WATER-SOLUBLE PHOSPHORUS INSECTICIDES. *Jour. Econ. Ent.* 48: 665-667.
- (47) GILBERT, I. H., GOUCK, H. K., and SMITH, C. N.  
1955. NEW MOSQUITO REPELENTS. *Jour. Econ. Ent.* 48: 741-743.
- (48) GINSBURG, J. M.  
1930. STUDIES OF PYRETHRUM AS A MOSQUITO LARVICIDE. *N.J. Mosquito Extermin. Assoc. Proc.* 17: 57-72, illus.
- (49) GJULLIN, C. M.  
1938. A MACHINE FOR SEPARATING MOSQUITO EGGS FROM SOIL. *U.S. Bur. Ent. and Plant Quar. ET-135*, 4 pp., illus.
- (50) ——— and CROSS, H. F.  
1950. THE EFFECTIVENESS OF SEVEN INSECTICIDES AGAINST ALASKAN MOSQUITO LARVAE IN DIFFERENT TYPES OF BREEDING AREAS. *Amer. Mosquito Control Assoc. and Va. Mosquito Control Assoc. Proc. and Papers* 1950, pp. 75-77.
- (51) ——— HEGARTY, C. P., and BOLLEN, W. B.  
1941. THE NECESSITY OF A LOW OXYGEN CONCENTRATION FOR THE HATCHING OF Aedes MOSQUITO EGGS. *Jour. Cell. and Compar. Physiol.* 17: 193-202.
- (52) ——— and ISAAK, L. W.  
1957. PRESENT STATUS OF MOSQUITO RESISTANCE TO INSECTICIDES IN THE SAN JOAQUIN VALLEY IN CALIFORNIA. *Mosquito News* 17: 67-70.
- (53) ——— ISAAK, L. W., and SMITH, G. F.  
1953. THE EFFECTIVENESS OF EPN AND SOME OTHER ORGANIC PHOSPHORUS INSECTICIDES AGAINST RESISTANT MOSQUITOES. *Mosquito News* 13: 4-7.
- (54) ——— and PETERS, R. F.  
1952. RECENT STUDIES OF MOSQUITO RESISTANCE TO INSECTICIDES IN CALIFORNIA. *Mosquito News* 12: 1-7.
- (55) ——— and PETERS, R. F.  
1956. TESTS WITH AERIAL SPRAYS OF MALATHION FOR THE CONTROL OF MOSQUITOES. *Mosquito News* 16: 84-86.
- (56) ——— WILSON, C. S., TRAVIS, B. V., and HUTTON, G. L.  
1949. THE RELATIVE EFFECTIVENESS OF SEVERAL INSECTICIDES AGAINST MOSQUITO LARVAE IN ALASKA. *Mosquito News* 9: 142-145.
- (57) ——— and YATES, W. W.  
1946. THE SURVIVAL OF Aedes VEXANS AND Aedes LATERALIS EGGS IN NATURE. *Calif. Mosquito Control Assoc. Ann. Conf. Proc. and Papers* 14: 89-92, illus.
- (58) ——— YATES, W. W., and STAGE, H. H.  
1950. STUDIES ON Aedes VEXANS (MEIG.) AND Aedes STICTICUS (MEIG.), FLOOD-WATER MOSQUITOES, IN THE LOWER COLUMBIA RIVER VALLEY. *Amer. Ent. Soc. Ann.* 43: 262-275, illus.
- (59) GOLDSMITH, J. B., HUSMAN, C. N., BROWN, A. W. A., and others.  
1949. EXPLORATORY STUDIES ON THE CONTROL OF ADULT MOSQUITOES AND BLACKFLIES WITH DDT UNDER ARCTIC CONDITIONS. *Mosquito News* 9: 93-96.
- (60) GRAHAM, J. E., REES, D. M., and EDMUNDS, G. F., JR.  
1953. A SEASON OF MOSQUITO CONTROL WITH HEPTACHLOR. *Calif. Mosquito Control Assoc. Ann. Conf. Proc. and Papers* 22: 21-22.
- (61) HAUFE, W. O.  
1954. THE EFFECTS OF ATMOSPHERIC PRESSURE ON THE FLIGHT RESPONSES OF Aedes Aegypti (L.). *Bul. Ent. Res.* 45: 507-526, illus.
- (62) HEDEEN, R. A., and KEEGAN, H. L.  
1952. THE USE OF LINDANE AND DIELDRIN AS MOSQUITO ADULTICIDES IN ALASKA. *Mosquito News* 12: 242-243.
- (63) HERMS, W. B., and GRAY, H. F.  
1944. MOSQUITO CONTROL. PRACTICAL METHODS FOR ABATEMENT OF DISEASE VECTORS AND PESTS. 419 pp., illus. N.Y.
- (64) HINMAN, E. H.  
1930. A STUDY OF THE FOOD OF MOSQUITO LARVAE (CULICIDAE). *Amer. Jour. Hyg.* 12: 238-270.

- (65) HOCKING, B.  
1952. AUTOLYSIS OF FLIGHT MUSCLES IN A MOSQUITO. *Nature* 169: 1101.
- (66) ———  
1952. PROTECTION FROM NORTHERN BITING FLIES. *Mosquito News* 12: 91-102.
- (67) ———  
1954. FLIGHT MUSCLE AUTOLYSIS IN *Aedes communis* (Degeer). *Mosquito News* 14: 121-123, illus.
- (68) ——— RICHARDS, W. R., and TWINN, C. R.  
1950. OBSERVATIONS ON THE BIONOMICS OF SOME NORTHERN MOSQUITO SPECIES (CULICIDAE: DIPTERA). *Canad. Jour. Res. (Sect. D)* 28: 58-80, illus.
- (69) HOFFMAN, R. A., and LINDQUIST, A. W.  
1952. RESIDUAL AND SPACE SPRAYS FOR THE CONTROL OF SNOW-WATER *Aedes* MOSQUITOES IN CAMP AREAS. *Mosquito News* 12: 87-91.
- (70) HOPKINS, D. M., KARLSTROM, T. N. V., and others.  
1955. PERMAFROST AND GROUND WATER IN ALASKA. *In* Shorter Contributions to General Geology 1954. *Geol. Survey Prof. Paper* 264, 205 pp., illus.
- (71) HORSFALL, W. R.  
1956. A METHOD FOR MAKING A SURVEY OF FLOODWATER MOSQUITOES. *Mosquito News* 16: 66-71, illus.
- (72) HUSBANDS, R. C.  
1952. SOME TECHNIQUES USED IN THE STUDY OF *Aedes* EGGS IN IRRIGATED PASTURES IN CALIFORNIA. *Mosquito News* 12: 145-150, illus.
- (73) HUSMAN, C. N.  
1949. SPRAY EQUIPMENT FOR C-47, UC-64 AND L-5 AIRPLANES. *Mosquito News* 9: 166-170, illus.
- (74) ———  
1953. A LIGHT, PNEUMATIC SPRAYER FOR INSTALLATION ON VEHICLES. *Mosquito News* 13: 134-138, illus.
- (75) JACHOWSKI, L. A., JR., and SCHULTZ, C.  
1948. NOTES ON THE BIOLOGY AND CONTROL OF MOSQUITOES AT UMIAT, ALASKA. *Mosquito News* 8: 155-165, illus.
- (76) JENKINS, D. W.  
1948. ECOLOGICAL OBSERVATIONS ON THE MOSQUITOES OF CENTRAL ALASKA. *Mosquito News* 8: 140-147, illus.
- (77) ——— and HASSETT, C. C.  
1951. DISPERSAL AND FLIGHT RANGE OF SUBARCTIC MOSQUITOES MARKED WITH RADIOPHOSPHORUS. *Canad. Jour. Zool.* 29: 178-187, illus.
- (78) JONES, R. W., III, and HOLTEN, J. R.  
1949. JEEP EXHAUST VENTURI AEROSOL. *Mosquito News* 9: 161-165, illus.
- (79) KELLER, J. C., and CHAPMAN, H. C.  
1953. TESTS OF SELECTED INSECTICIDES AGAINST RESISTANT SALT-MARSH MOSQUITO LARVAE. *Jour. Econ. Ent.* 46: 1004-1006.
- (80) KNIGHT, K. L.  
1948. A TAXONOMIC TREATMENT OF THE MOSQUITOES OF UMIAT, ALASKA. *U.S. Nav. Med. Res. Inst. Rpt. No. 2*, 12 pp., illus.
- (81) ———  
1951. THE *Aedes* (Ochlerotatus) PUNCTOR SUBGROUP IN NORTH AMERICA. *Amer. Ann. Ent. Soc.* 44: 87-99, illus.
- (82) KNIPLING, E. F., GJULLIN, C. M., and YATES, W. W.  
1943. A NEW OIL-EMULSION MOSQUITO LARVICIDE. *U.S. Bur. Ent. and Plant Quar.* E-587, 4 pp.
- (83) McDUFFIE, W. C., SHARP, J. F., CROSS, H. F., and others.  
1949. THE EFFECTIVENESS OF PREHATCHING TREATMENTS FOR THE CONTROL OF ARCTIC MOSQUITOES. *Mosquito News* 9: 51-56.
- (84) MARSHALL, J. F.  
1938. THE BRITISH MOSQUITOES. 341 pp., illus. London.
- (85) MATHESON, R.  
1944. HANDBOOK OF THE MOSQUITOES OF NORTH AMERICA. 314 pp., illus. Ithaca, N. Y.
- (86) NATIONAL DEFENSE RESEARCH COMMITTEE.  
1945. DEVELOPMENT OF AN EXHAUST DDT AEROSOL GENERATOR FOR THE ¼ TON, 4 x 4 TRUCK ("JEEP"). OSRD No. 6301, NRC Insect Control No. 139. 41 pp., illus.
- (87) NATVIG, L. R.  
1948. NORSK ENTOMOLOGISK TIDSSKRIFT. SUP. I. CONTRIBUTIONS TO THE KNOWLEDGE OF THE DANISH AND FENNOSCANDIAN MOSQUITOES. *CULICINI*. 567 pp. Oslo.

- (88) NIELSEN, E. T., and GREVE, H.  
1950. STUDIES ON THE SWARMING HABITS OF MOSQUITOES AND OTHER NEMATOCERA. *Bul. Ent. Res.* 41 : 227-258, illus.
- (89) PETROF, I.  
1900. POPULATION, RESOURCES, ETC., OF ALASKA. [FROM U.S. CENSUS REPORT OF 1880.] *In* Compilation of Narratives of Explorations in Alaska. 56th Cong., 1st Sess., Senate Rpt. No. 1023. 856 pp., illus. Wash., D.C.
- (90) PRATT, R. L.  
1949. WEATHER AND ALASKAN INSECTS. Off. of the Quartermaster Gen., Mil. Planning Div., Res. and Devlpmt. Branch, Environmental Sect. Climatic Res. Lab. Rpt. No. 156. 25 pp., illus.
- (91) RAFFERTY, J. J.  
1900. FROM PORT VALDEZ TO COPPER RIVER, DOWN THAT RIVER, THENCE TO PRINCE WILLIAM SOUND. *In* Compilation of Narratives of Explorations in Alaska. 56th Cong., 1st Sess., Senate Rpt. No. 1023. 856 pp., illus. Wash., D.C.
- (92) RALEY, T. G.  
1947. CALIFORNIA GROUND THERMAL AEROSOL GENERATOR. *Mosquito News* 7 : 58-63, illus.
- (93) ———  
1952. THE PLUMBER'S NIGHTMARE, KING SIZE. *Mosquito News* 12 : 141-144, illus.
- (94) RAYMOND, C. P.  
1900. RECONNOISSANCE OF THE YUKON RIVER, 1869. *In* Compilation of Narratives of Explorations in Alaska. 56th Cong., 1st Sess., Senate Rpt. No. 1023. 856 pp., illus. Wash., D.C.
- (95) ROSS, E. S., and ROBERTS, H. R.  
1943. MOSQUITO ATLAS. PT. I. THE NEARCTIC ANOPHELES; IMPORTANT MALARIA VECTORS OF THE AMERICAS AND AEDES AEGYPTI, CULEX QUINQUEFASCATUS. 44 pp., illus. Phila.
- (96) ROTH, A. R., YATES, W. W., and LINDQUIST, A. W.  
1947. PRELIMINARY STUDIES OF LARVICIDES ON SNOW-WATER MOSQUITOES. *Mosquito News* 7 : 154-156.
- (97) SMITH, C. N., GILBERT, I. H., and GOUCK, H. K.  
1958. USE OF INSECT REPELLENTS. U.S. Agr. Res. Serv. ARS-33-26, rev., 6 pp.
- (98) STAGE, H. H.  
1951. MOSQUITO CONTROL AGENCIES IN THE UNITED STATES. *Mosquito News* 11 : 8-22, illus.
- (99) ——— and CHAMBERLIN, J. C.  
1945. ABUNDANCE AND FLIGHT HABITS OF CERTAIN ALASKAN MOSQUITOES, AS DETERMINED BY MEANS OF A ROTARY-TYPE TRAP. *Mosquito News* 5 : 8-16, illus.
- (100) ——— GJULLIN, C. M., and YATES, W. W.  
1937. FLIGHT RANGE AND LONGEVITY OF FLOODWATER MOSQUITOES IN THE LOWER COLUMBIA RIVER VALLEY. *Jour. Econ. Ent.* 30 : 940-945, illus.
- (101) STEFANSSON, V.  
1921. THE FRIENDLY ARCTIC. THE STORY OF FIVE YEARS IN POLAR REGIONS. 784 pp., illus. N.Y.
- (102) STIVERS, J. O.  
1956. PHOSPHATE USE IN CALIFORNIA MOSQUITO CONTROL. *Mosquito News* 16 : 87-91.
- (102a) STONE, A., KNIGHT, K. L., and STARCKE, H.  
1959. A SYNOPTIC CATALOG OF THE MOSQUITOES OF THE WORLD (DIPTERA, CULICIDAE). 358 pp. Entomological Society of America, College Park, Md.
- (103) TRAVIS, B. V., APPLEWHITE, K. H., FRITH, G. R., and GOLDSMITH, J. B.  
1953. ADDITIONAL OBSERVATIONS ON THE CONTROL OF MOSQUITO LARVAE IN ALASKA WITH DDT. *Mosquito News* 13 : 1-3.
- (104) ——— APPLEWHITE, K. H., and SMITH, N.  
1950. CONTROL OF MOSQUITO LARVAE IN ALASKA WITH DDT. *Jour. Econ. Ent.* 43 : 350-353.
- (105) ——— GJULLIN, C. M., BLANTON, F. S., and others.  
1949. PREHATCHING TREATMENT FOR THE CONTROL OF AEDES IN ALASKA. *Mosquito News* 9 : 42-48.

- (106) TULLOCH, G. S.  
1934. MOSQUITO INVESTIGATIONS IN ALASKA. *Psyche* 41: 201-210, illus.
- (107) UNITED STATES DEPARTMENT OF AGRICULTURE, ENTOMOLOGY RESEARCH BRANCH.  
1955. INSECTICIDES AND REPELLENTS FOR THE CONTROL OF INSECTS OF MEDICAL IMPORTANCE TO THE ARMED FORCES. U.S. Dept. Agr. Cir. 977, 91 pp., illus.
- (108) VANNOTE, R. L.  
1954. EXPERIENCE WITH GRANULAR INSECTICIDES FOR MOSQUITO CONTROL IN EASTERN UNITED STATES. *N.J. Mosquito Extermin. Assoc. Proc.* 41, pp. 123-126.
- (109) VOCKEROTH, J. R.  
1954. NOTES ON THE IDENTITIES AND DISTRIBUTIONS OF Aedes SPECIES OF NORTH-EARN CANADA, WITH A KEY TO THE FEMALES (DIPTERA: CULICIDAE). *Canad. Ent.* 86: 241-255.
- (110) WASHBURN, G. E.  
1954. EXPERIENCE WITH GRANULAR INSECTICIDES IN THE WESTERN UNITED STATES. *N.J. Mosquito Extermin. Assoc. Proc.* 41, pp. 118-123.
- (111) \_\_\_\_\_  
1956. GRANULAR PESTICIDES IN CALIFORNIA MOSQUITO CONTROL. *Mosquito News* 16: 104-105.
- (112) WHITEHEAD, F. E.  
1951. RICE FIELD MOSQUITO CONTROL BY PELLET-BORNE INSECTICIDES. *Ark. Agr. Expt. Sta. Bul.* 511, 30 pp.
- (113) WILSON, C. S.  
1950. AEROSOL SPRAY UNITS FOR CONTROL OF BITING INSECTS. *Mosquito News* 10: 51-54, illus.
- (114) \_\_\_\_\_  
1951. CONTROL OF ALASKAN BITING INSECTS. *U.S. Pub. Health Rpts.* 66: 917-922.
- (115) WRAY, F. C.  
1946. SIX GENERATIONS OF Culex pipiens WITHOUT A BLOOD MEAL. *Mosquito News* 6: 71-72, illus.
- (116) YATES, W. W., and GJULLIN, C. M.  
1947. PRE-HATCHING APPLICATIONS OF DDT LARVICIDES ON FLOODWATER Aedes MOSQUITOES. *Mosquito News* 7: 4-6.

# Appendix

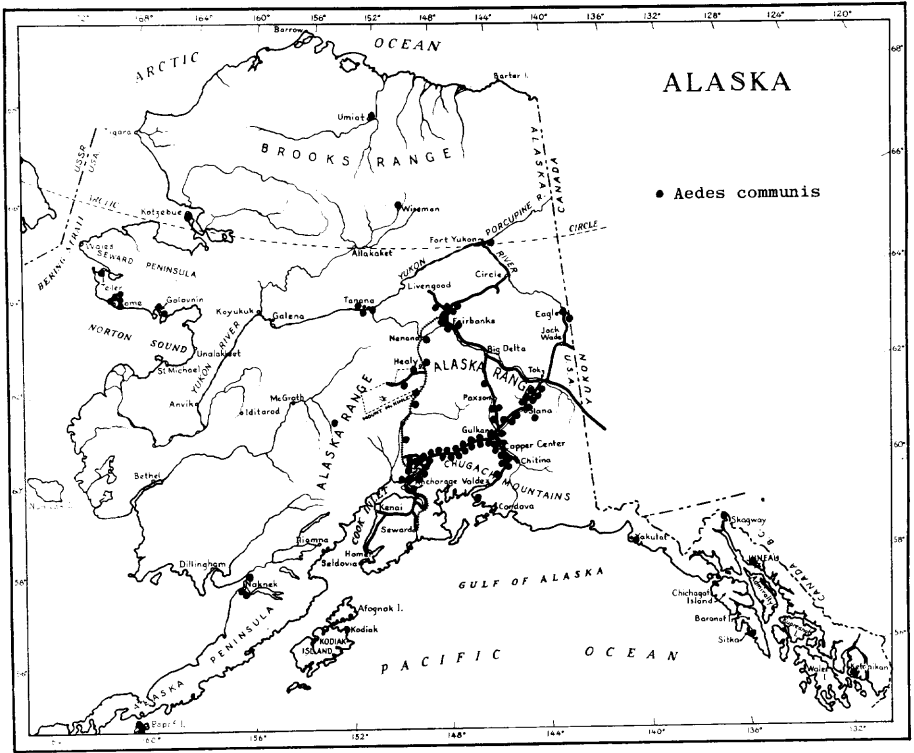

PN-889

MAP 1.—Distribution of *Aedes communis*.

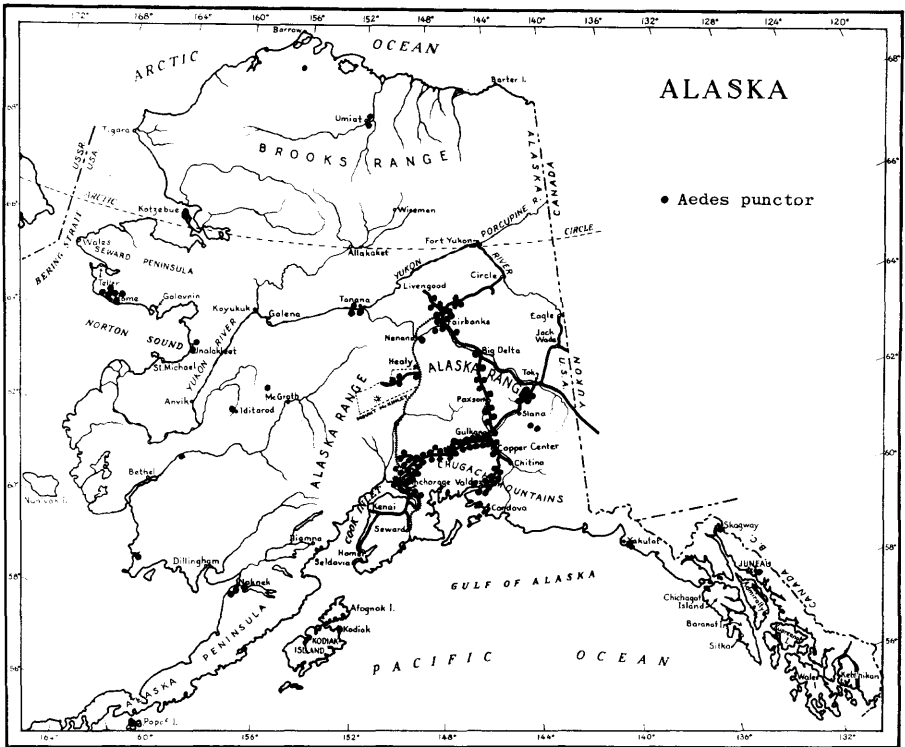

PN-890

MAP 2.—Distribution of *Aedes punctor*.



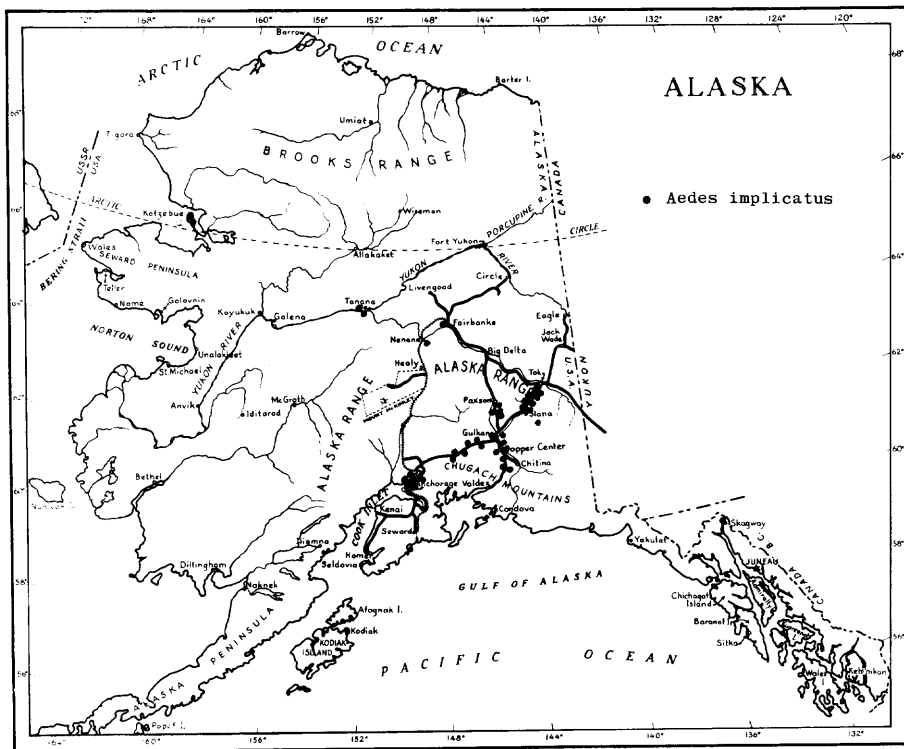

PN-891

MAP 3.—Distribution of *Aedes implicatus*.

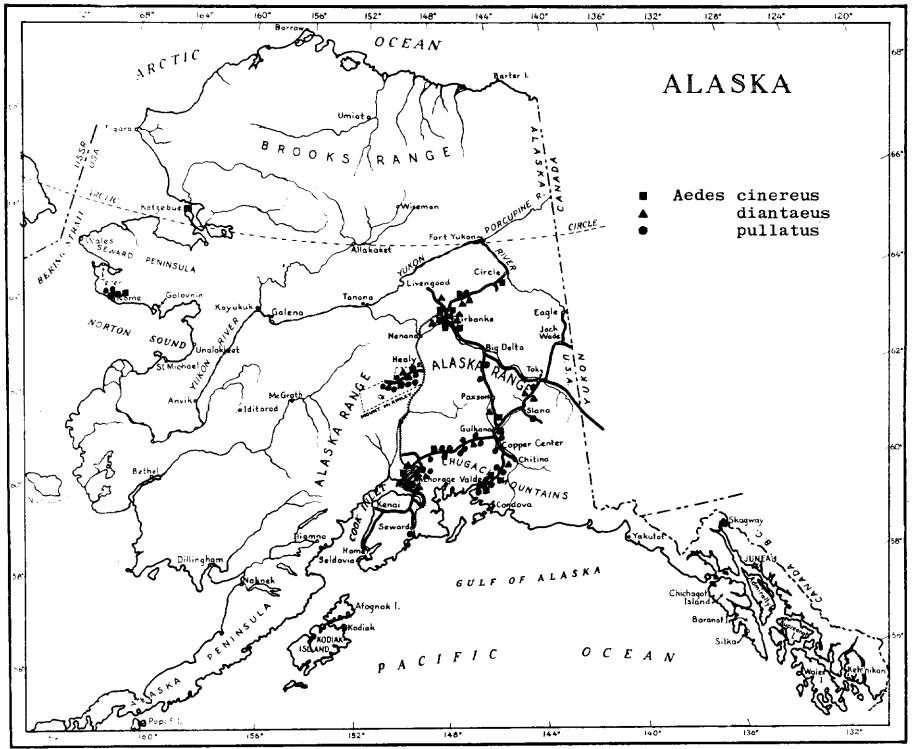

MAP 4.—Distribution of *Aedes cinereus*, *diantaeus*, and *pullatus*.

PN-892

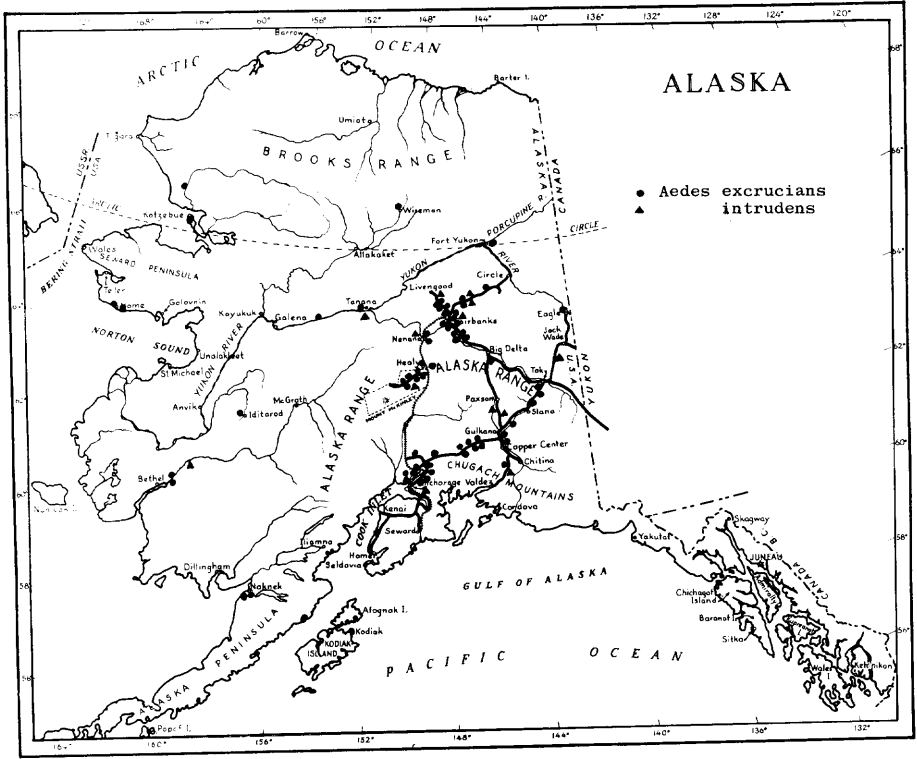

PN-893

MAP 5.—Distribution of *Aedes excrucians* and *intrudens*.

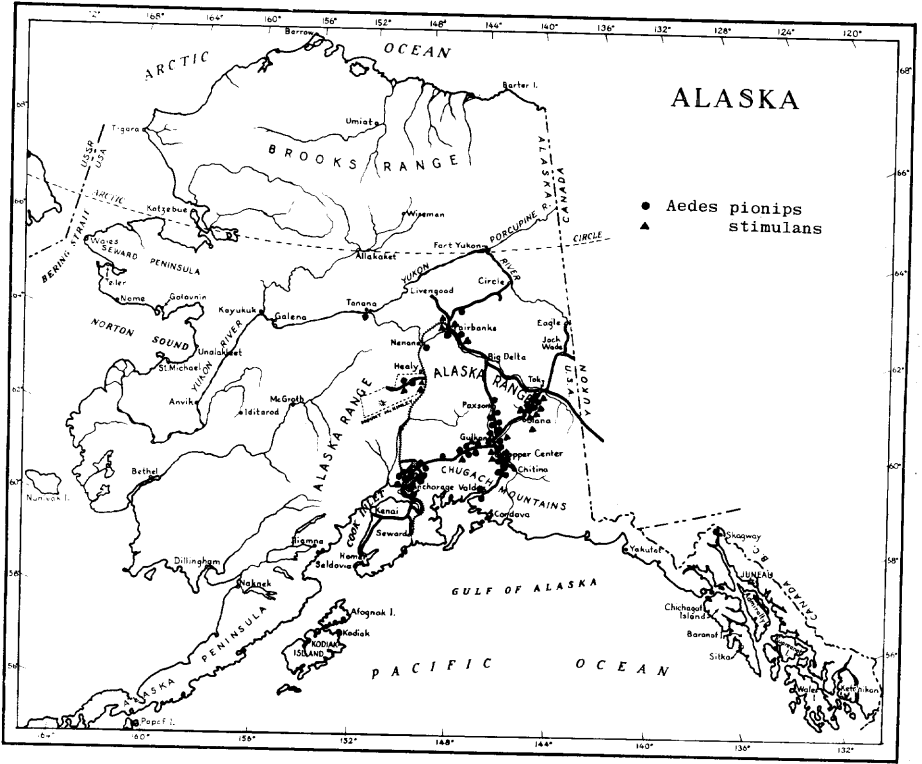

MAP 6.—Distribution of *Aedes pionicus* and *stimulans*.

PN-894

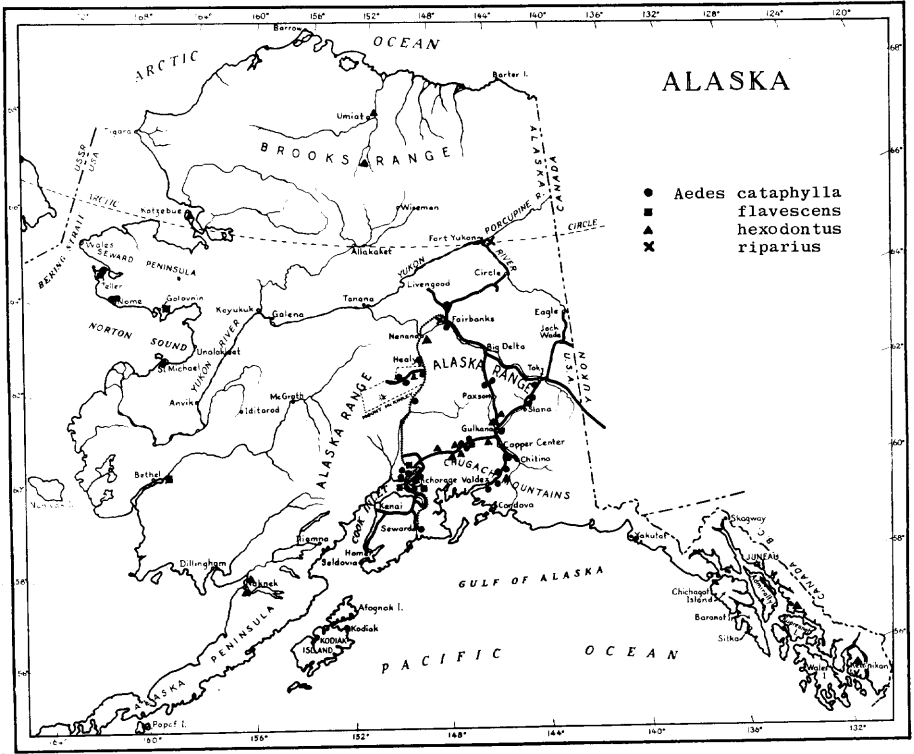

PN-895

MAP 7.—Distribution of *Aedes cataphylla*, *flavescens*, *hexodontus*, and *riparius*.

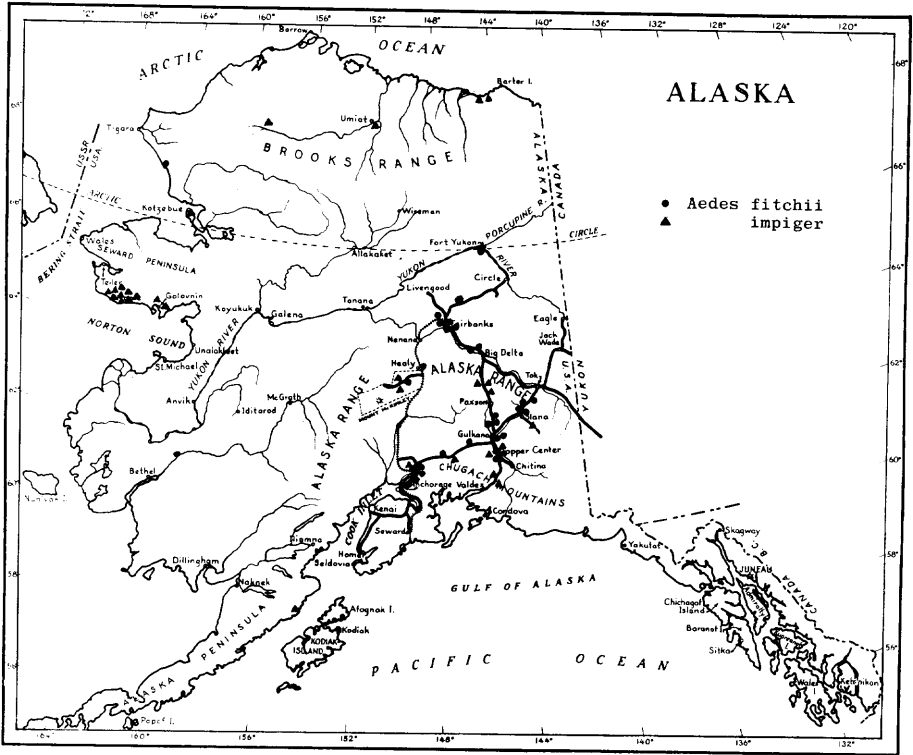

MAP 8.—Distribution of *Aedes fitchii* and *impiger*.

PN-896

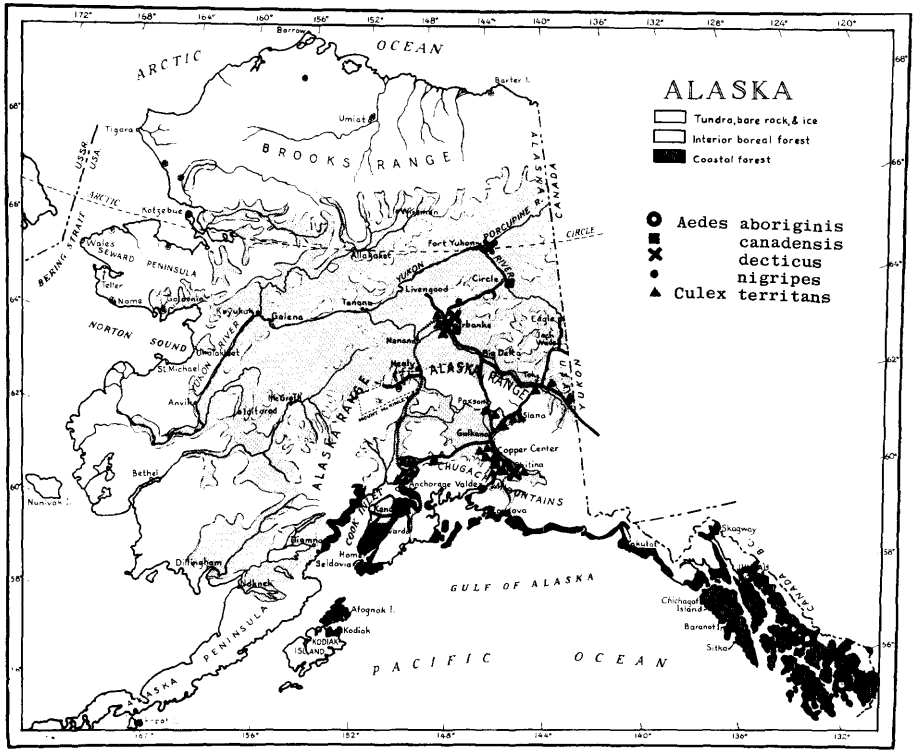

PN-897

MAP 9.—Distribution of *Aedes aboriginis*, *canadensis*, *decticus*, *nigripes*, and *Culex territans*.

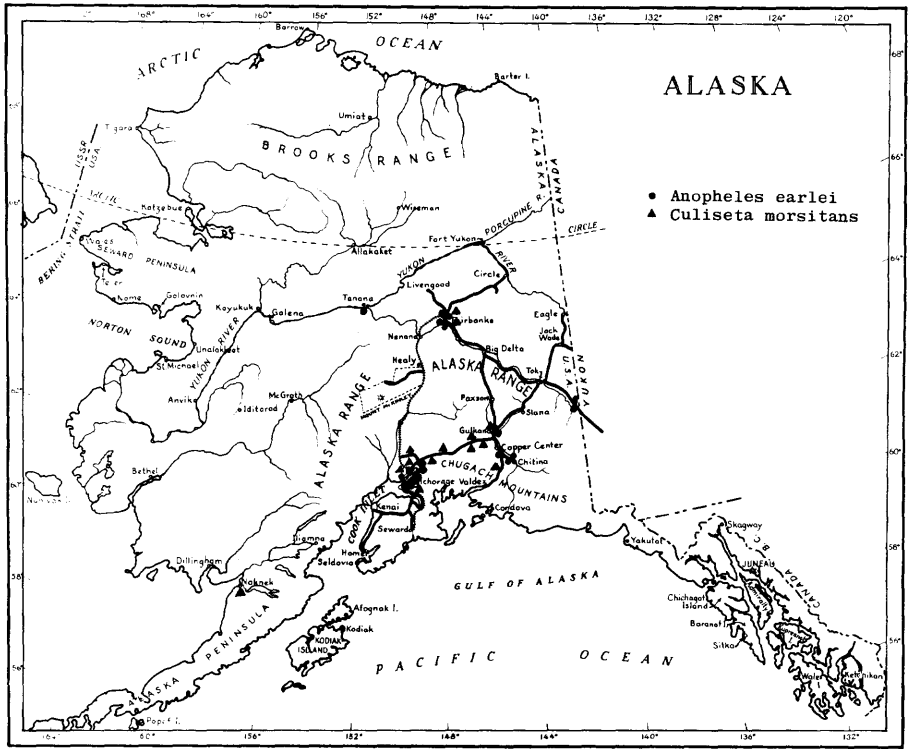

PN-898

MAP 10.—Distribution of *Anopheles earlei* and *Culiseta morsitans*.



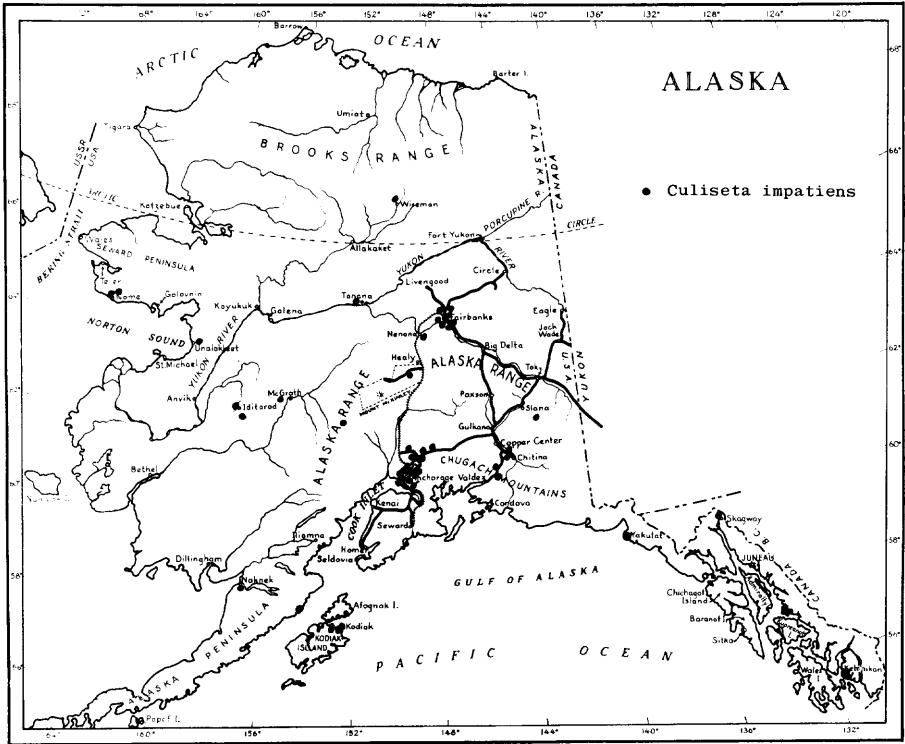

MAP 11.—Distribution of *Culiseta impatiens*.

PN-899

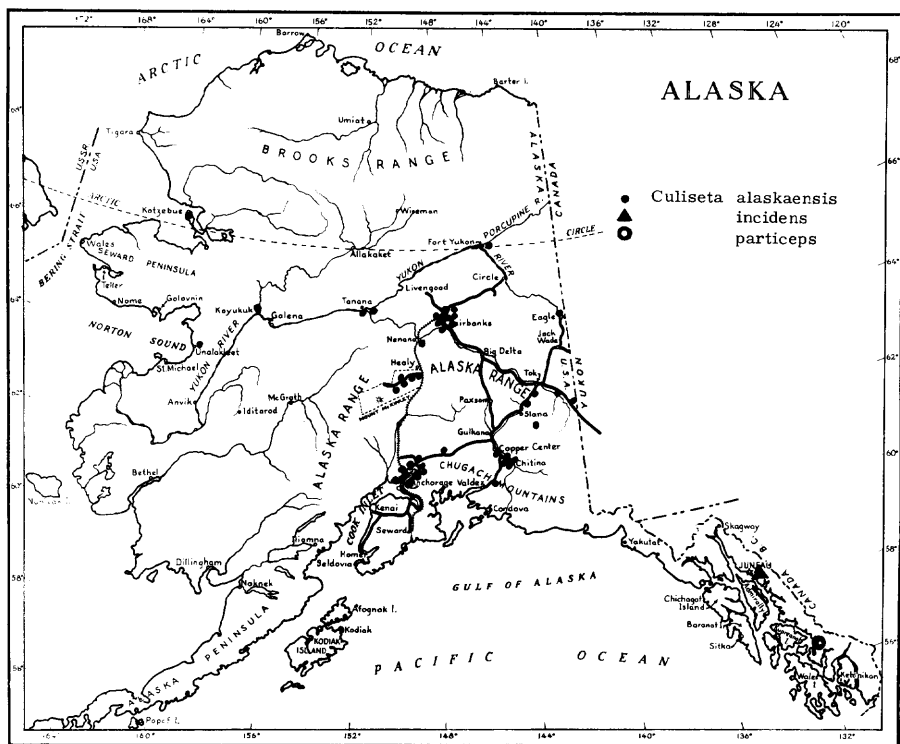

PN-900

MAP 12.—Distribution of *Culiseta alaskaensis*, *incidens*, and *particeps*.